



FIAMMA F45S POLAR WHITE



Fiamma's side-wall mount awning. This is Fiamma's best selling awning and is delivered with aluminium end caps dual lead bar guide rail and many other innovative features.



DELUXE GREY



BLUE OCEAN



SAHARA



EVERGREEN



BORDEAUX



PEARL

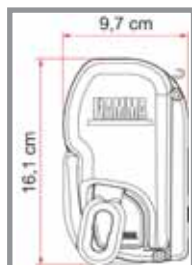

F45L POLAR WHITE

Same style of awning as F45S but has a larger carcass. Features include double fascia guide, drip moulding, arms pre-set for LED lights, reinforced leg knuckle, lower groove for attaching rain guard lower, dual shock absorber and aluminium end caps.

F45S 190 GREY	15113
F45S 230 GREY	15120
F45S 260 BLUE	15130
F45S 260 GREY	15131
F45S 260 SAHARA	15132
F45S 260 EVERGREEN	15133
F45S 260 BORDEAUX	15134
F45S 260 PEARL	15135
F45S 300 BLUE	15136
F45S 300 GREY	15137
F45S 300 SAHARA	15138
F45S 300 EVERGREEN	15139
F45S 300 BORDEAUX	15140
F45S 300 PEARL	15141
F45S 350 BLUE	15148
F45S 350 GREY	15149
F45S 350 SAHARA	15150
F45S 350 EVERGREEN	15151
F45S 350 BORDEAUX	15152
F45S 350 PEARL	15153
F45S 400 BLUE	15160
F45S 400 GREY	15161
F45S 400 SAHARA	15162
F45S 400 EVERGREEN	15163
F45S 400 BORDEAUX	15164
F45S 400 PEARL	15165
F45S 450 BLUE	15172
F45S 450 GREY	15173
F45S 450 SAHARA	15174
F45S 450 EVERGREEN	15175
F45S 450 BORDEAUX	15176
F45S 450 PEARL	15177
F45L 450 BLUE	16145
F45L 450 BORDEAUX	16146
F45L 450 SAHARA	16147
F45L 450 EVERGREEN	16148
F45L 450 GREY	16149
F45L 450 PEARL	16150
F45L 500 BLUE	16151
F45L 500 BORDEAUX	16152
F45L 500 SAHARA	16153
F45L 500 EVERGREEN	16154
F45L 500 GREY	16159
F45L 500 PEARL	16160
F45L 550 BLUE	16161
F45L 550 BORDEAUX	16162
F45L 550 SAHARA	16163
F45L 550 EVERGREEN	16164
F45L 550 GREY	16165
F45L 550 PEARL	16166

F45S TITANIUM & F45L TITANIUM



- F45S TITANIUM 260 GREY 16275
- F45S TITANIUM 300 GREY 16284
- F45S TITANIUM 350 GREY 16293
- F45S TITANIUM 400 GREY 16300
- F45S TITANIUM 450 GREY 16310

- F45L TITANIUM 450 GREY 16330
- F45L TITANIUM 500 GREY 16599
- F45L TITANIUM 550 GREY 16609

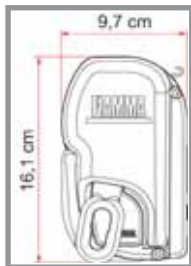

Other colours of canvas are available to order. For the full list of options please refer to the price list.

F45S DEEP BLACK



- F45S 260 GREY 15129



F45S VW T5 AWNING



- F45S 260 TITANIUM UK SPEC T5 MULTIVAN GREY 16517
- F45S 300 TITANIUM UK SPEC T5 MULTIVAN GREY 16520

- F45S 260 TITANIUM CALIFORNIA 16509

*Continental spec VW T5 awning options are available to order...please refer to price list to see part numbers / options.

All of the awnings listed above come with brackets included.

Note: In the case of the Multivan VW, the awning is installed onto the roof rail which is standard delivered with the vehicle. In the case of the Transporter model this is not fitted by VW as standard, speak to your local VW stockist regarding this item.

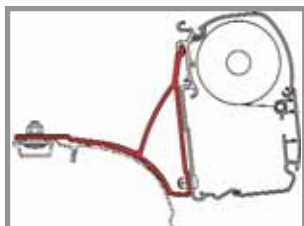

***VW T5 MULTIVAN COMFORTLINE - TRANSPORTER**

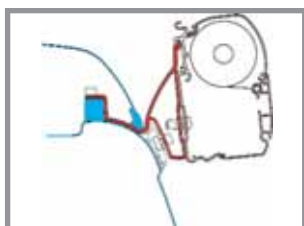

VW T5 CALIFORNIA



F45 EAGLE

FIAMMA F45 Eagle



Automatic extra-strong awning without legs. Delivered as standard with wind sensor and full length mounting bracket. The Eagle is a 12V electric awning that is opened and closed by using a wall switch.

F45 EAGLE 3.5M Polar White – GREY	16530
F45 EAGLE 4.0M Polar White – GREY	16532
F45 EAGLE 4.5M Polar White – GREY	16534

FIAMMA ZIP



The Fiamma Zip quickly doubles your living space



**DELUXE
GREY**



**BLUE
OCEAN**

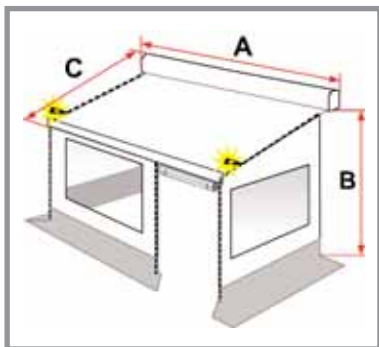

ZIP TOP

ZIP 300 TOP GREY	17302
ZIP 300 TOP BLUE	17303
ZIP 350 TOP GREY	17304
ZIP 350 TOP BLUE	17305
ZIP 400 TOP GREY	17306
ZIP 400 TOP BLUE	17307
ZIP 450 TOP GREY	17308
ZIP 450 TOP BLUE	17309

ZIP PRIVACY ROOM

ZIP 300 MEDIUM	17327
ZIP 300 LARGE	17328
ZIP 350 MEDIUM	17329
ZIP 350 LARGE	17330
ZIP 400 MEDIUM	17331
ZIP 400 LARGE	17332
ZIP 450 MEDIUM	17333
ZIP 450 LARGE	17334
SIDE DOOR PANEL RIGHT ZIP MEDIUM	17339
SIDE DOOR PANEL RIGHT ZIP LARGE	17340

Fiamma now give the user the option of buying an additional Side Panel which is fitted with a door. The Side Door Panel is for fitting in place of the RH Side Panel that is delivered with the Zip Privacy Room.



New optional RH Side Panel with door

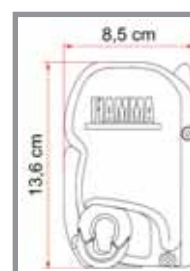

**ZIP 300
ZIP 350**



**ZIP L 400
ZIP L 450**

MEASUREMENT B

225-250CM = MEDIUM
251-280CM = LARGE

OPTIONAL BRACKETS FOR MOUNTING F45S / F45TIL / ZIP

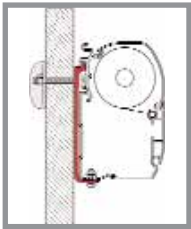

KIT AS 120
Standard delivered for awnings
from 250 to 400cm.
2 pcs. 12cm brackets
1 pc. 8cm bracket **71516**

KIT AS 400
Standard delivered for awnings
from 450cm – 500cm.
2 pcs. 40cm brackets
1 pc. 12cm bracket **18111**

KIT AS 400L
Standard delivered for 550cm
awnings.

4 pcs. 40cm brackets **18113**

KIT S 400
1 pc. 40cm bracket **18112**

ADAPTER AS 300
3M Long Bracket **18105**

ADAPTER AS 350
3.5M Long Bracket **18106**

ADAPTER AS 400
4.0M Long Bracket **18107**

ADAPTER AS 450
4.5M Long Bracket NEW **18108**

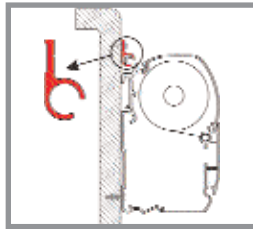

R RAIL
3M Length **18070**
4M Length **18090**

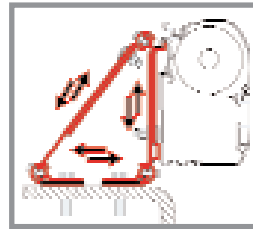

KIT MULTI
1 pc. Kit **18150**

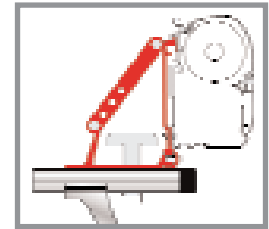

**KIT AUTO
ADAPTOR**
2 pcs. 8cm brackets **23091**

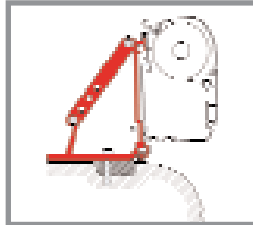

KIT VW T5
Transporter Multivan
"Trendline" **17760**

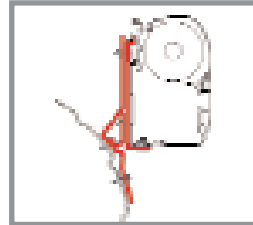

KIT VW T4
VW T4 Lift Roof
2 pcs. 8cm brackets **17770**

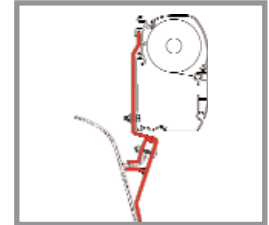

KIT VW T3
2 pcs.
8cm brackets. **17780**

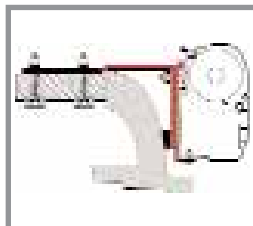

**KIT MERCEDES
VITO**
2 pcs. 8cm brackets. **17990**

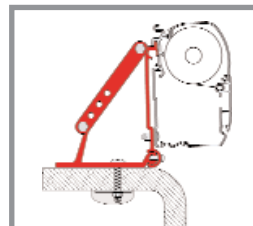

**KIT ROOF
ADAPTOR**
3 pcs. 8cm brackets. **18160**

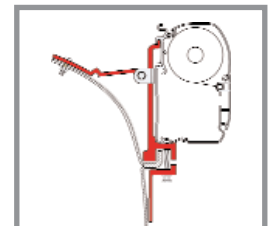

KIT VAN
2 pcs. **17790**

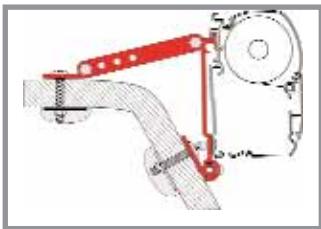

**KIT WALL
ADAPTOR**
3 pcs. 8cm brackets **18170**

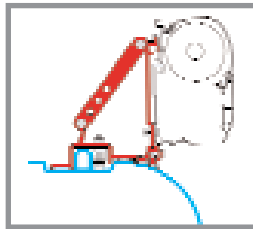

**KIT DUCATO –
JUMPER – BOXER**
Before March 2006
2 pcs. 8 cm brackets **18002**

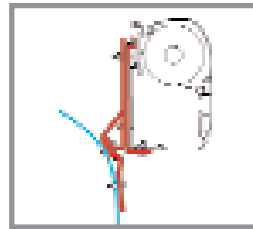

**KIT DUCATO –
MASTER**
2 pcs. 14cm brackets **18000**

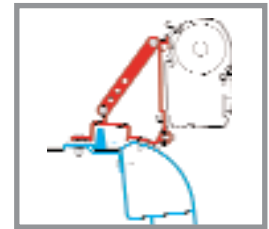

**KIT RENAULT
MASTER 98**
3 pcs. 8cm brackets **18004**

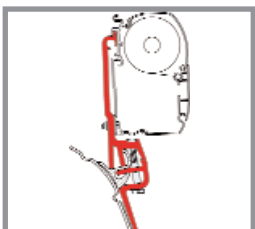

KIT BRANDRUP
2 pcs. 8cm brackets **17740**

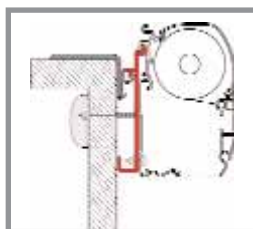

KIT RAPIDO 9
2 pcs. 8cm brackets
2 pcs. 12cm brackets **17961**

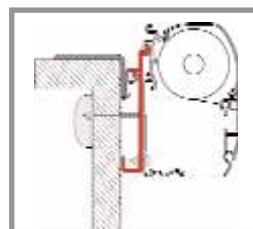

KIT RAPIDO 7-8
2 pcs. 8cm brackets
1 pc. 100cm bracket **17960**

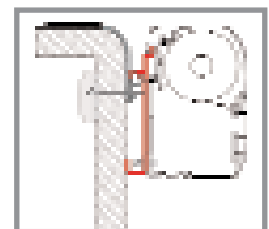

ADAPTOR RAPIDO
350cm bracket **17962**
400cm bracket **17963**

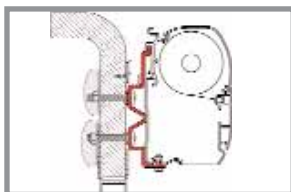

HYMER CAMP
3 pcs. 12cm brackets **17800**
300cm bracket **17810**
350cm bracket **17820**
400cm bracket **17830**
450cm bracket **17831**
500cm bracket **17832**

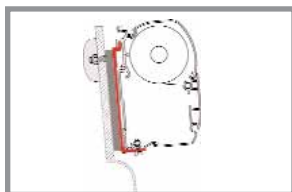

HIGH ROOF ADAPTOR WESTFALIA
3 pcs. 12cm brackets **18161**



EURA MOBIL
400cm bracket **17702**

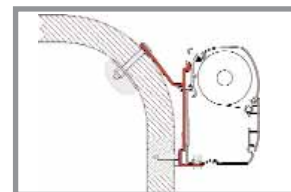

KIT MOBILVETTA NAZCA
3 pcs. 12cm brackets **18204**

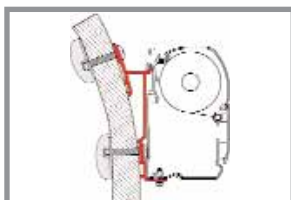

HYMER S-E KLASSE
350cm bracket **17890**
400cm bracket **17900**
450cm bracket **17910**
500cm bracket **17920**

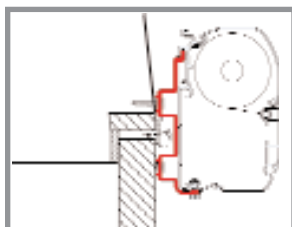

HYMER EXSIS
300cm bracket **18008**

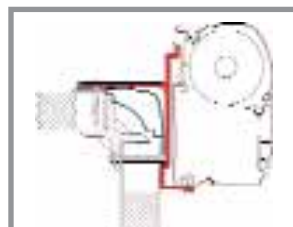

KIT LAIKA ECOVIP BURSTNER - HOBBY
3 pcs. 15cm brackets
1 pc. 12cm bracket **18152**
390cm bracket **18154**

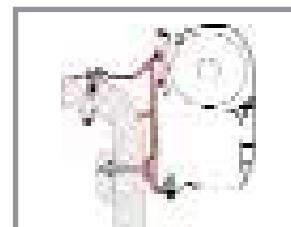

HYMER VAN/B2
2 pcs. 8cm + 2 x 35cm brackets (kit) **17840**
350cm bracket **17850**
400cm bracket **17860**
450cm bracket **17870**

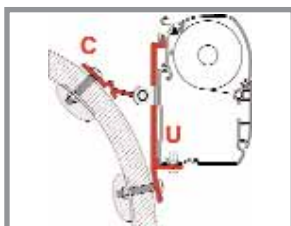

KIT HYMER S
3 pcs. 8cm brackets **18020**
3 pcs. 8cm brackets **18130**
You need to order 3 of each of the above bracket in order to make this kit.

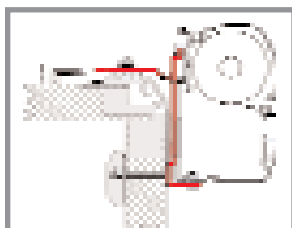

KIT MOBILVETTA ICARO
3 pcs. 12cm brackets **DISCONTINUED**

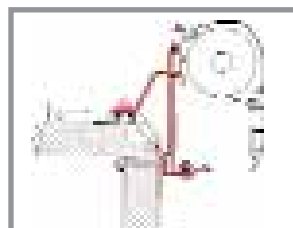

KIT MOBILVETTA EUROYACHT
3 pcs. 12cm brackets **18201**

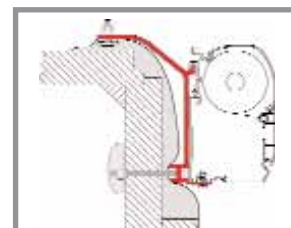

MOBILVETTA BLUELINE
For awnings up to 350cm order **3 x 18200**
For awnings from 400cm on order **4 x 18200**

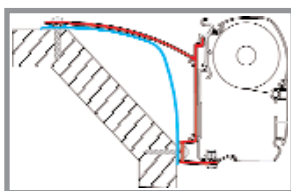

KIT LAIKA ECOVIP
3 pcs. 15cm brackets
For awnings from 400cm onwards **18153**

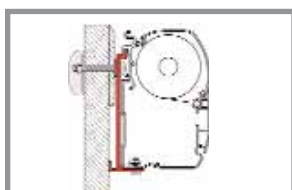

KIT CHALLENGER-CHAUSSON
2 pcs. 8cm brackets
1 pc 40cm bracket **17950**

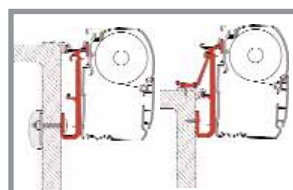

KIT CARAVAN
3 pcs. 13cm brackets **17970**

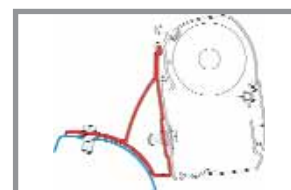

KIT TRAFIC/VIVARO
F45 220 for SWB
F45 250 for LWB
2 pcs. 16cm brkts **17998**

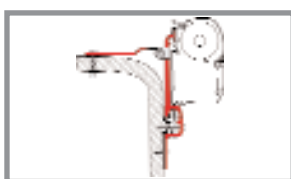

KIT ERIBA TOURING
3 pcs. 8cm brackets **17980**

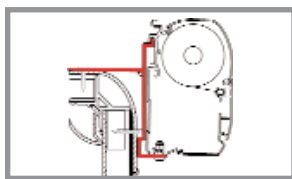

KIT PILOTE EXPLORER
3 pcs. 15cm brackets **18206**

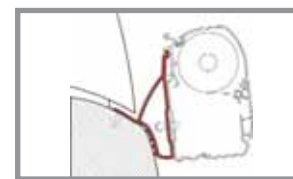

HYMER CAR 302
2 pcs. 12cm brackets **DISCONTINUED**

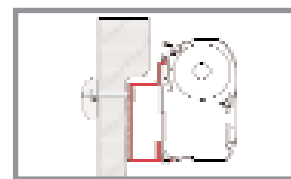

EURA MOBIL KARMANN
350cm bracket **18742**
400cm bracket **18743**
450cm bracket **18744**

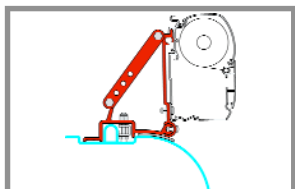

KIT FIAT DUCATO 2006

2 pcs. 8cm brackets

18724

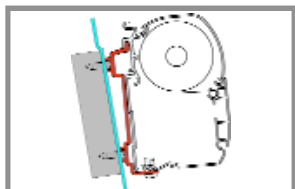

KIT FORD TRANSIT HIGH ROOF SPRINTER / VW CRAFTER

2 pcs. 40cm brackets

18208

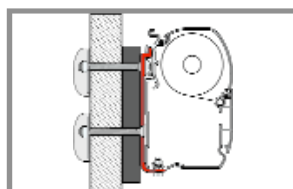

KIT DETHLEFFS GLOBUS

3 pcs. 12cm brackets

18207

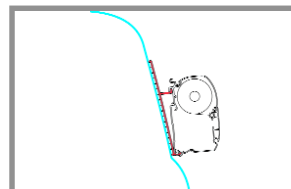

KIT FIBRE-GLASS ROOF

2 pcs. 40cm brackets

18211

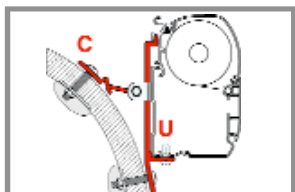

KIT VOYAGEUR

3 pcs. 8cm brackets

18020

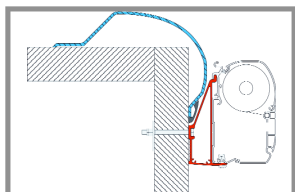

ADAPTER ARCA

1 x 4M brkt **18242**

1 x 4.5M brkt **18243**

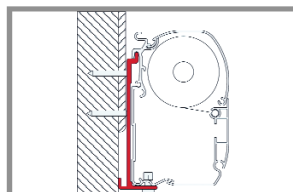

KIT FLEURETTE

1x 8cm brkt

2 x 12cm brkts **18245**

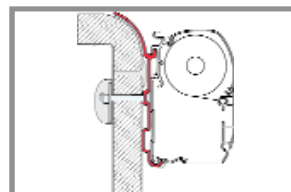

KIT BURSTNER

2 pcs. 12cm brackets

1 pc. 8cm bracket

18734

3 pcs. 8cm brackets

18130

You need to order 3 of each of the above bracket in order to make this kit.

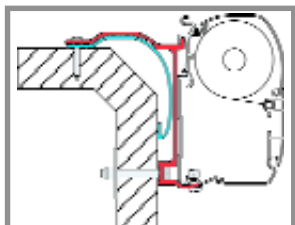

KIT LAIKA REXOSLINE - ECOVIP 07

3 pcs. 15cm brackets

18214

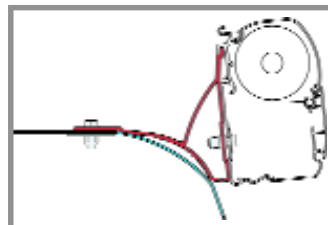

KIT DUCATO WITH ROOF RACK

3 pcs. 12cm brackets

18723

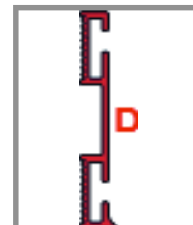

ADAPTOR D

8cm **18030**

12cm **18031**



KIT LAIKA X 2008

3 pcs. 15cm brackets

18213



ADAPTOR C **18020**

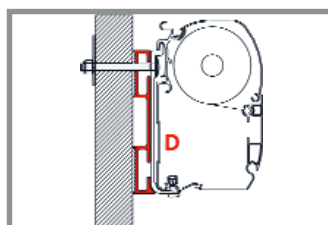

ADAPTOR D

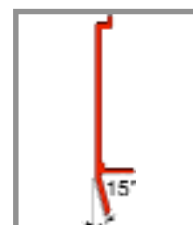

ADAPTOR U

18130

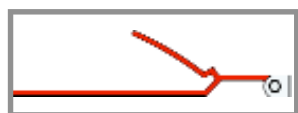

ADAPTOR B **18010**

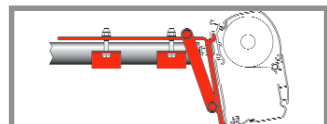

KIT ROOF RAIL

1 pc. 8cm bracket

Min. 2 kits to install

an awning **18005**

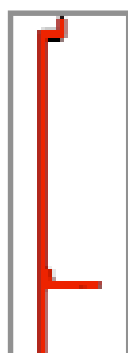

ADAPTOR T

18120

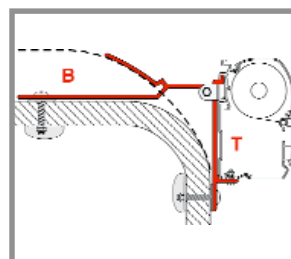
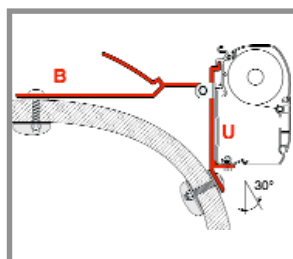
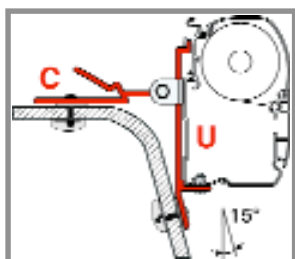
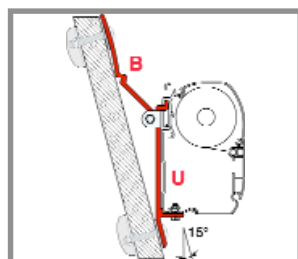
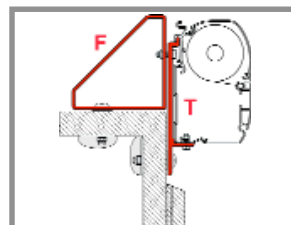
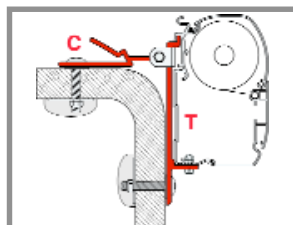
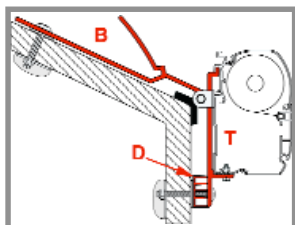

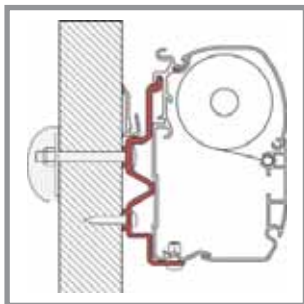

**ADAPTOR RAPIDO
90DF - 10**
350CM **17956**
400CM **17957**
450CM **17958**

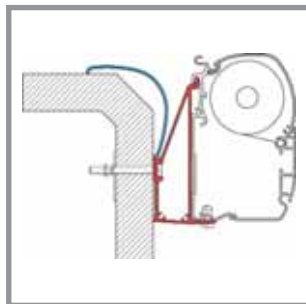

**ADAPTOR SERIES 6
RAPIDO BRACKET**
300CM **17965**
350CM **17966**
400CM **17967**

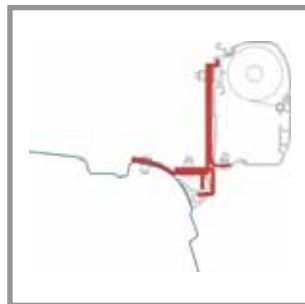

**KIT MULTIRAIL
REIMO VW T5**
2 pcs. 12cm bkts
17745

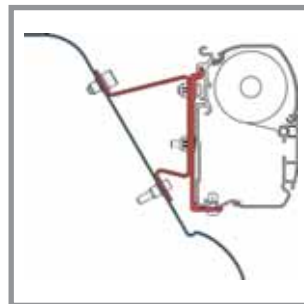

**KIT SPRINTER H3
SPRINTER H3
WESTFALIA
CRAFTER H3**
3 pcs. 8cm bkts
18216

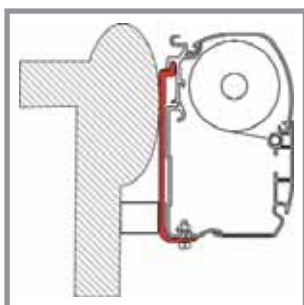

**ADAPTOR KNAUS C
LINER**
300CM
17951

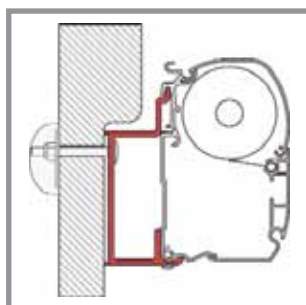

**ADAPTOR EURA
MOBIL KARMANN**
350CM **18742**
400CM **18743**
450CM **18744**

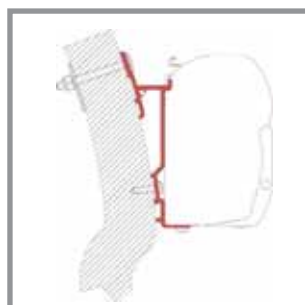

**ADAPTOR
WINGAMM OASI**
1 pc. 230cm bkt **17791**
1 pc. 300cm bkt **17792**
1 pc. 350cm bkt **17793**

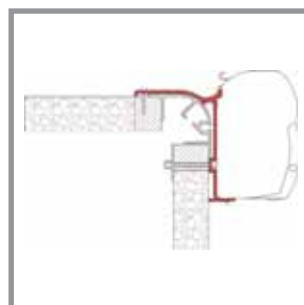

**KIT BAILEY
PEGASUS**
3 pcs. 15cm bkts
17690

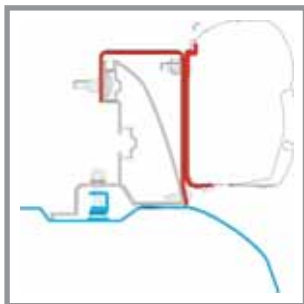

**KIT FIAT DUCATO
H2 ROOF RAIL**
3 pcs. 12cm bkts
18003

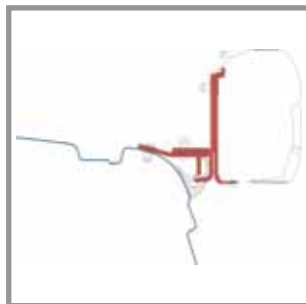

**KIT BRANDRUP
VW T5**
2pcs. 12cm bkts
17748

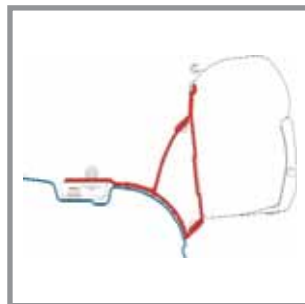

**KIT VW T5
TRANSPORTER
MULTIVAN UK SPEC**
2 pcs. 21.5cm bkts
17747

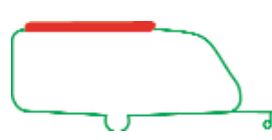
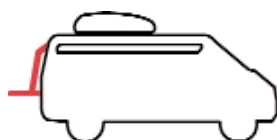

BRACKETS FOR EVERY KIND OF VEHICLE!



Doubles your living space!

The Fiamma Privacy is the only enclosure that allows you full aeration on all windows. With the Privacy Room you can transform your awning into a comfortable living area.

The side panels are quickly put together with the exclusive patented Fast Clip that combines the canopy with the side walls. No other fixing system is as stable as the Fiamma Fast Clip. A protective foam is fitted vertically on the back part of the side panels along the support pole to guarantee a close fit. The front panel is inserted in the front rail of the awning and with the zipper joined to the side panels.



Front and side panels are composed of openable Crystal windows equipped with mosquito net. High Velcro layer for safe closing of the window

F45S / F45L PRIVACY ROOMS

PRIVACY ROOM 260 VWT5 VAN	21498
FRONT PANEL 40 VWT5	21499
PRIVACY ROOM 300 MEDIUM	21504
PRIVACY ROOM 300 LARGE	21512
PRIVACY ROOM 350 MEDIUM	21506
PRIVACY ROOM 350 LARGE	21514
PRIVACY ROOM 400 MEDIUM	21508
PRIVACY ROOM 400 LARGE	21516
PRIVACY ROOM 450 MEDIUM	21510
PRIVACY ROOM 450 LARGE	21518
PRIVACY ROOM 500 LARGE	21520
PRIVACY ROOM 550 LARGE	21522
SIDE DOOR PANEL RIGHT MEDIUM	21560
SIDE DOOR PANEL RIGHT LARGE	21562



Delivered with Fast Clip for quick and easy installation.

F65S / F65L PRIVACY ROOMS

PRIVACY ROOM 320 DUCATO (AFTER 06/2006)	18677
PRIVACY ROOM 320 CARAVAN NEW	18685
PRIVACY ROOM 320 MERC SPRINTER	18684
PRIVACY ROOM 20CM FRONT PANEL	18686
PRIVACY ROOM 50CM FRONT PANEL	18687
PRIVACY ROOM 80CM FRONT PANEL	18688



New optional RH Side Panel with door

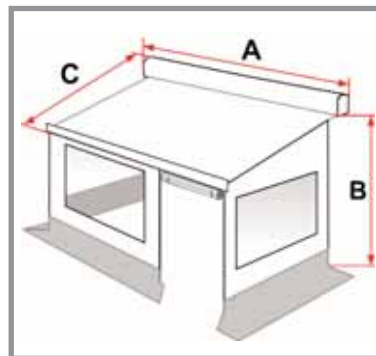

In order to measure an awning to find the correct Privacy, please ensure that you check measurement B correctly

- 180-220 CM = VAN
- 225-250 CM = MEDIUM
- 251-280 CM = LARGE

Fiamma F45S / F45L Privacy's will also fit F50, F55, F1, F1L, F45i, F45iL, F45Ti, and F45TiL awnings (and also the Omnistor 5002/5003 awnings).

KIT MAGIC PRIVACY



Optional structure ideal for increasing stability of front / side panels of Privacy Rooms. Very useful in cases of wind. Composed by one or more Magicrafter and Door Pole according to the length of the Privacy.

- Kit Magic Privacy Front 260/280/300/310/350 & 360 19950
- Kit Magic Privacy Front 400/410/440 19951
- Kit Magic Privacy Front 500/550 19952
- Kit Magic Privacy Side 19953

PRIVACY ROOM LIGHT



The Privacy Room Light: lighter and more compact for holidays on the move



The light Fiamma enclosure. Made of durable weather resistant grey polyester that when folded up, takes up little space. It's standard delivered with the new Fiamma Clip System S Light with Quick Lock handles to easily fasten to the front of the awning. The two side panels are provided with a roller blind and mosquito screens for good ventilation. The front panel slides in to the front rail of the roller tube and thanks to the auto-lubrication zippers fastens easily to the lateral panels. The door can be moved to the left or right hand side. The side panels stick to the wall of the vehicle with the standard delivered elastic ropes, provided with quick hooks. It can be used with the optional Tie Down S. Standard delivered with Mega Bag Light and the elegant Ocean curtains in plain blue for the front window. Also suitable for the Omnistor 5002 and 5003 awnings.



The two side panels are provided with roller blind and mosquito screens

- Privacy Room Light 3.0M MEDIUM 21548
- Privacy Room Light 3.5M MEDIUM 21550
- Privacy Room Light 4.0M MEDIUM 21551
- Privacy Room Light 3.0M LARGE 21549
- Privacy Room Light 3.5M LARGE 21553
- Privacy Room Light 4.0M LARGE 21554



Delivered with Curtains kit Ocean



Delivered with Mega Bag Light



Kit Poles Light (Optional) 21359

If your customer wants to see how to erect a Privacy Room or Privacy Room Light then refer them to the Fiamma website. There are installation videos on almost everything! www.fiamma.com There are quick links to most of the Fiamma videos / schematics from the Nova Leisure website too www.novaleisure.com



BLOCKER PRO

BLOCKER PRO

Front panel equipped with one large full light crystal window and vinyl extension to floor. Made of rot-proof vinyl, washable fabric with UV protection. Simple to install using elastic hooks and pegs provided.

- Blocker Pro 250 20630
- Blocker Pro 260 20628
- Blocker Pro 260 VW T5 20639
- Blocker Pro 300 20632
- Blocker Pro 350 20634
- Blocker Pro 400 20636
- Blocker Pro 450 20640



BLOCKER

BLOCKER

Convenient front panel to protect you from sun-light and rain and give you more privacy. 140cm high. Easy to install by using pegs provided.

- Blocker 300 20727
- Blocker 350 20728
- Blocker 400 20732



SIDE W PRO

SIDE W PRO

Convenient side panel with a large full light Crystal window and vinyl extension to the floor. Made of rot-proof vinyl, washable fabric with UV protection. Simple to install. Delivered as standard with telescopic tension rafter and elastic hooks / pegs.

- Side W Pro F45 20666
- Side W Pro F45 VW T5 20668
- Side W Pro XXL F45 20669
- Side W Pro F65S / F65L Ducato 20665
- *Side W Pro F45 Shade Right **NEW** 20670
- *Side W Pro F45 Shade Left **NEW** 20671
- *New version of Side W Pro that has a roll down blind built-in enabling the user Privacy when required.



SUN VIEW XL

- Kit Side F65S / F65L 20664
- Kit Side Omnistor 5002/5003 21391
- Kit Side Tristor 21392
- Kit Side Omnistor 4900/Tristor 21393

SUN VIEW XL

Convenient front panel for Fiamma F45S/F45L and F65S/F65L awnings. Made with translucent light filtering material blocks about 80% of the light. Can be rolled up thanks to handy clips. Delivered with ropes and pegs.

- Sun View XL 300 20560
- Sun View XL 350 20562
- Sun View XL 400 20564
- Sun View XL 450 20566



SUN VIEW SIDE

SUN VIEW SIDE

Convenient side panel for Fiamma F45 awnings. Can be fitted to F65 awnings (and other type) by ordering the relevant Side Kit above. Made with translucent light filtering material, blocks about 80% of the light. Easy to fix. Delivered with telescopic rafter, ropes and pegs.

20576

RAFTER

Anodised aluminium tension rafter supplied with special wall clips for storage inside of the vehicle. Complete with rubber ends so it can be used on other brands of awning. **19970**

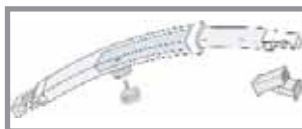
RAFTER PRO

Curved rafter. Eliminates water pooling and noisy flapping of fabric in wind. Easy to install design. Complete with rubber ends so it can be used on other brands of awning. **19980**

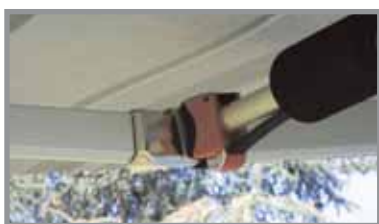
MAGIC RAFTER

Innovative universal telescopic rafter in anodised aluminium. It is easily installed by hooking the ends onto the awning arms, while keeping them tight to avoid bending. It also fits awnings of other brands.

Magic Rafter Standard (2.5M – 4.0M awnings)
Magic Rafter XL (4.5M – 5M awnings)

19969
19968

MAGIC RAFTER PRO

The innovative model of the Fiamma universal and telescopic Magic Rafter Pro. It comes complete with two special brackets to fix in the knuckles of the arms in order to keep the fabric under tension. The perfect tool to prevent water pooling caused by the rain and the noisy flapping of the fabric in the wind. It doesn't ruin the fabric. Easy to install and suitable to be fitted on other brands of awning. Magic Rafter Pro Standard (3.5M – 4.5M awnings)

19962

RAFTER LED

Telescopic rafter LED with 17 strong and brilliant LED lights made of solid anodised aluminium. Suitable for most of the box awnings for motorhomes on the market. **19983**

AWNING ARMS LED

LED lighting system composed of 4 LED light kits mounted on a proper support easily attached to the case awning arms. **28292**

LED AWNING CASE

Convenient form of lighting for external use on F45S and F45L awnings. 3M kit comprises of 6 individual strips that slide together below the awning in to the rear channel. It means that you do not have to have the awning open in order to enjoy lighting. For larger lengths of awning just add as necessary the optional 50cm kit LED awning case x as many as required.

3M AWNING CASE
KIT LED AWNING CASE 50CM

28280
28281

LED AWNING LIGHT



External LED light for awnings. Made of solid painted aluminium. It includes 31 LED lights with intense white light that don't heat; they are isolated for external use and the electrical consumption is low. Dimensions: L 57.4cm x W 3.6cm x H 3.2cm

28290

LED AWNING LIGHT RGB



Similar to LED AWNING LIGHT, but consists of 8 colours and 30RGB Leds. Also comes complete with remote control that enables the colour and brightness to be controlled.

28279

LED SENSOR AWNING LIGHT



External LED light specially made to be installed on the door of your motorhome or caravan. Similar characteristics to the Awning light above but complete with motion and light sensors.

28282

LED GARAGE LIGHT



Internal LED light for storage compartments and garage facilities. Similar to lights above but with on/off switch.

28284

KIT AWNING LED



Lighting system to be installed on F45 and F65 awnings. It is composed of two 10 LED lights, low consumption, 12V power supply cable 5M long. In the F45TiL awning, the cable is hidden within the arm. Also fits previous models of awning.

28305

KIT CABLES GUIDE



Kit of 2 flexible profiles, ideal for awnings with arms provided with guide preset for the passing of cables. Each profile is 1225mm long, Ø6.5mm.

28289

KIT CABLES RAIL



Kit of 2 compact rails, ideal for all awnings that don't have preset channels for electrical cables. Dimensions (each rail): 1225mm L x 13mm W x 3mm H

28293

RAFTER LED CS



The perfect way to illuminate your Caravanstore / F35 Pro awning. Rafter LED CS comes complete with 5M of cable, cigar lighter plug and on / off switch. Simple to use.

19982

LED WARNING SOLAR



Kit of 2 LED solar powered lights that flash intermittently. Ideal for positioning around the Caravan / Motorhome to highlight dangerous spots. During twilight hours the 6 red LEDs flash intermittently. The lights are delivered with retainers that allow them to be installed on steps, Carry Bike rails, Privacy Rooms, Tie Down straps and many other items.

19896

LED AWNING LIGHT GUTTER



Innovative version of the classic Fiamma LED awning light. LED Awning Light Gutter is for fitting above the habitation door on a vehicle and is cleverly shaped to prevent dripping. Dimensions: 3.5 x 8 x 69cm

28276

LED DIMMER



All Fiamma LED lights can be used with the LED dimmer. Dimmer can be built in or recessed. Dimensions: 8 x 8 x 4cm
Colour: White

28274

LED STEP

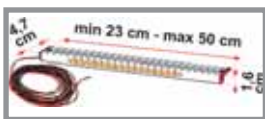

New LED low consumption lighting system for the entrance of the motorhome, to increase security and stability of the steps and step wells. Made of strong anodised aluminium and complete with 6 x 12V low consumption LEDs and with wiring for connection.

27711

TIE DOWN KIT (A)



A

Available in Black or Yellow.
Black Tie Down Kit
Yellow Tie Down Kit

19893

19892

TIE DOWN KIT S (B)

Available in Black or Yellow.
Black Tie Down Kit S
Yellow Tie Down Kit S

19894

19895

TIE DOWN S CARAVANSTORE

Tie Down S Caravanstore Black (not illustrated)
(Locates in to the leg of the Caravanstore / F35 Pro awning)

19891



B

DOOR POLE



Optional privacy room and zip front telescopic pole.
Gives extra stability to awning fascia and Privacy.

19984

RAPID SET (A)

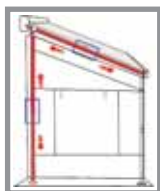

A



B

Replacement Zip awning poles. Can be used with older style Privacy side panels and on some other brands of Privacy rooms. **21360**

CLIP SYSTEM S EXTENSION 250 (B) **21394**

The Clip System S is the newest design of Fiamma Clip System poles and is complete with Fast Clip locking system. It is delivered as standard with Fiamma Privacy Rooms.

CRANK HANDLE



For winding Fiamma awnings out.
Standard handle
Telescopic handle

20050

20060

MOTOR KITS



- F45S Polar White Motor Kit **19810**
- F45S Titanium Motor Kit **19811**
- F45L Polar White Motor Kit **19814**
- F45L Titanium Motor Kit **19815**
- F65S Polar White Motor Kit **19816**
- F65S Titanium Motor Kit **19817**
- F65L Polar White Motor Kit **19802**
- F65L Titanium Motor Kit **19800**
- F65S Integrated Motor Kit **19803**

SPOILER



SPOILER S



SPOILER M

Optional spoiler for Fiamma awnings with an exclusive design to reduce wind resistance and also improve the aesthetics of the vehicle. It can be attached on the right or the left side. It is made of ABS PLUS with coextruded UV protection. It can be easily fastened to the vehicle wall with SIKA. Colour: Polar White and Titanium.

S – F45 Ti / TiL – Polar White 16 x 15.5cm

20096

M – F45 TiL – Polar White 27.5 x 19cm

20094

REPAIR KIT PLUS



It is no longer necessary to replace the fabric of the awning if it gets cut. With the new magic repair kit plus from Fiamma, the do-it-yourself repair is so quick and easy! The kit includes 3 transparent PVC strips. **19941**

KIT AWNING HANGERS



Kit of 6 hooks to insert in the lead bar profile to hang light objects. Suitable also for other awning brands with 7mm slot.

30047

SKIRTING



Optional protection against wind and rain that eliminates draft. Suitable for all Fiamma Privacy Rooms and can easily be shortened. Available in 4 versions.

- Skirting Motorhome (5.5M x 60cm) **21370**
- Skirting Caravan (4.5M x 60cm) **21369**
- Skirting VW T5 (2.5M x 42cm) **21368**
- Skirting Ducato (4.25M x 55cm) **21367**

RAIN GUARD LOWER



For F45S awnings with suspended installation spaced from the wall. Installation is into the special guide of the case. Sold on 20M Roll.

20024

RAIN GUARD S

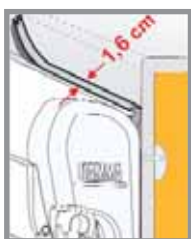

For awning installed with standard AS 120 brackets on flat walls. Sold on 30M Roll.

20020

RAIN GUARD M



For awnings mounted with adapter spaced out from wall (up to 4cm) or on curved walls. Sold on 30M Roll.

20022

RAIN GUARD L

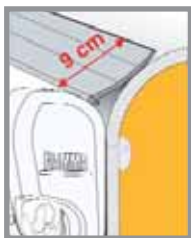

For awnings mounted with adaptor spaced out from the wall (up to 9cm) or on curved walls. Sold on Roll.

19991

KIT RAIN GUARD F65 / F65S



For roof awnings F65 and F65S. Covers the whole space between the roof and the awning. Length – 4M. Made from strong EPDM.

19990



F65S



F65L

The F65S is Fiamma's roof mount awning. It is proving ever more popular. The F65L is the same style of awning but has a bigger carcass making it stronger.



The F65L comes with dual lead bar rail, allowing the user the use of multiple items.

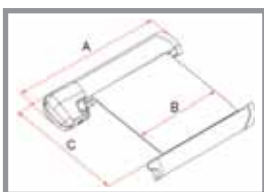
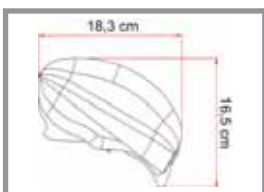

F65S 290 BLUE OCEAN	18404
F65S 290 DELUXE GREY	18406
F65S 320 BLUE OCEAN	18408
F65S 320 DELUXE GREY	18410
F65S 340 BLUE OCEAN	18412
F65S 340 DELUXE GREY	18414
F65S 370 BLUE OCEAN	18416
F65S 370 DELUXE GREY	18418
F65S 400 BLUE OCEAN	18420
F65S 400 DELUXE GREY	18422
F65L 400 BLUE OCEAN	18666
F65L 400 DELUXE GREY	18667
F65L 450 BLUE OCEAN	18668
F65L 450 DELUXE GREY	18669
F65L 490 BLUE OCEAN	18670
F65L 490 DELUXE GREY	18671

F65S & F65L TITANIUM

F65S 320 TITANIUM DELUXE GREY	18432
F65S 340 TITANIUM DELUXE GREY	18436
F65S 370 TITANIUM DELUXE GREY	18440
F65S 400 TITANIUM BLUE OCEAN	18442
F65S 400 TITANIUM DELUXE GREY	18444
F65L 400 TITANIUM BLUE OCEAN	18672
F65L 400 TITANIUM DELUXE GREY	18673
F65L 450 TITANIUM BLUE OCEAN	18674
F65L 450 TITANIUM DELUXE GREY	18675
F65L 490 TITANIUM BLUE OCEAN	18680
F65L 490 TITANIUM DELUXE GREY	18681

F65S DEEP BLACK

F65S 320 DEEP BLACK DELUXE GREY	18452
F65S 370 DEEP BLACK DELUXE GREY	18456
F65S 400 DEEP BLACK DELUXE GREY	18459

F65 EAGLE



New automatic extra-strong legless awning, designed for roof installation. Delivered with 12vdc motor and Wind Detective System which means that in case of strong wind the awning will automatically retract.

F65 EAGLE 400 POLAR WHITE DELUXE GREY	16540
F65 EAGLE 400 TITANIUM DELUXE GREY	16542
KIT STANDARD F65 EAGLE 400	16544

F65 MOUNTING BRACKETS



KIT IVECO DAILY H2 (H2 Model Only)
2 pcs. 15cm brackets
1 pc. 20cm bracket
18721



KIT IVECO DAILY H3 (H3 Model Only)
3 pcs. 15cm brackets
18718



KIT RENAULT MASTER
2 pcs. 29cm brackets
1 pc. 12cm bracket
18726

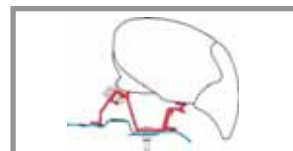

KIT MERCEDES SPRINTER / VW CRAFTER UK SPEC Highroof
1 pc. 12cm bkt
1 pc. 53cm bkt
1 pc. 60cm bkt
after 2006 **18728**

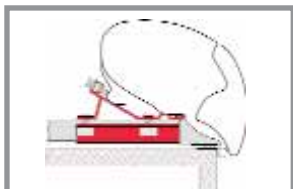

KIT FIXING BAR
3 pcs. 20cm brackets
18700

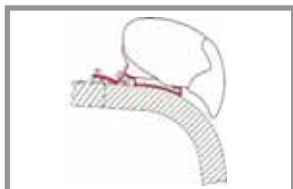

KIT GIOTLINE / FENDT
3 pcs. 15cm brackets
for Gentetics/
Graal **18719**
for Sunny **18702**



KIT DUCATO-JUMPER-BOXER HIGH ROOF
2 pcs. 20cm brackets
(no drilling necessary)
18717



KIT DUCATO-JUMPER-BOXER
2 pcs. 20cm brackets
(no drilling necessary)
18716



KIT DUCATO-JUMPER-BOXER HIGH ROOF
2 pcs. 20cm brackets
with closing rubber joints
1 pc. 12cm bkt
after 06/2006 **18727**

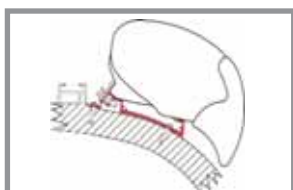

CARTHAGO CHIC
1 x 400cm bracket **18735**
1 x 450cm bracket **18736**
1 x 500cm bracket **18737**

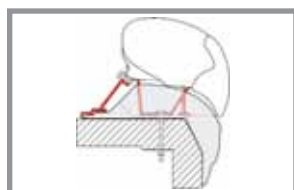

KIT ARCA
2 pcs. 20cm brackets
18764

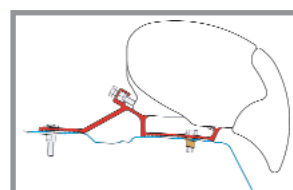

KIT RENAULT MASTER H2 OPEL MOVANO H2 NISSAN NV400 H2
1 pc. 12cm bkt
1 pc. 44cm bkt
1 pc. 64cm bkt
18762

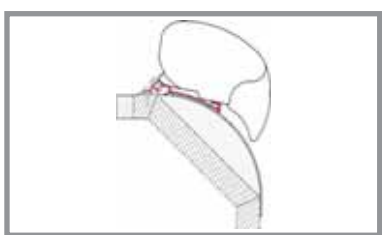

KIT LAIKA KREOS 05
3 pcs. 15cm brackets
18713

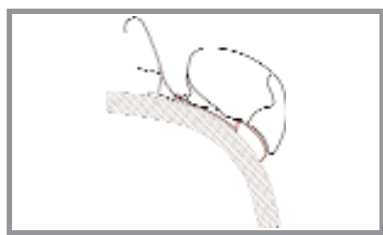

LAIKA KREOS
1 x 370cm bracket **18714**
1 x 400cm bracket **18715**

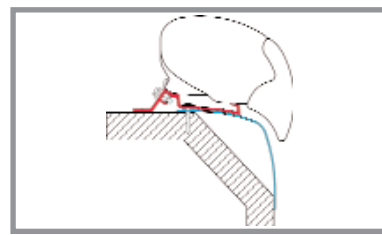

LAIKA REXSOSLINE
4 pcs. 15cm brackets
18738

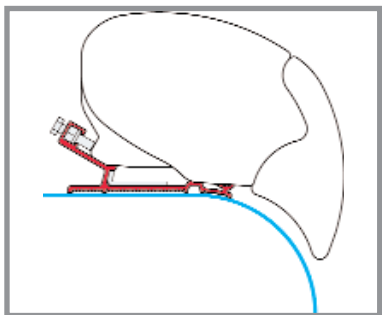

AUTOCRUISE
3 pcs. 15cm bkts **18710**

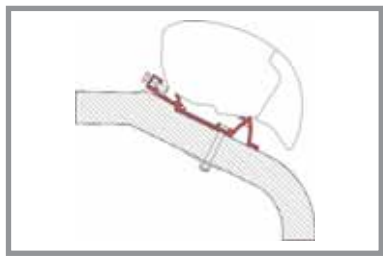

ADAPTOR LMC - TEC
F65 LMC 290cm bkt **18750**
F65 LMC 340cm bkt **18751**
F65 LMC 370cm bkt **18752**
F65 LMC 400cm bkt **18753**
F65 LMC 450cm bkt **18754**



KIT SPRINTER ROOF RAIL
2pc. 40cm bkts
1 pc. 12cm bkt
18704

FIAMMA F65 BRACKETS



KIT STANDARD

3 pcs. 20cm bkts

18760

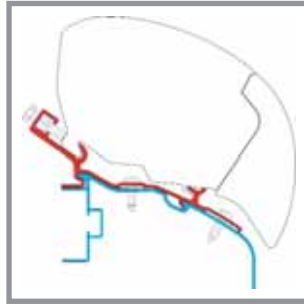

ADAPTOR ELDDIS

1 pc. 370cm bkt

18765

1 pc. 400cm bkt

18766

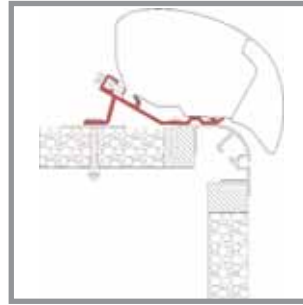

KIT BAILEY PEGASUS

3 pcs. 25cm bkts

18770

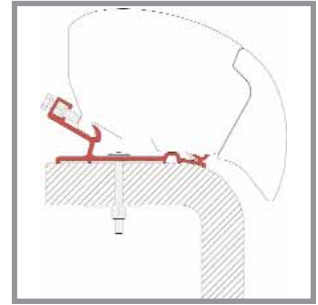

ADAPTER HYMER

1 pc. 290cm bkt

18771

1 pc. 320cm bkt

18772

1 pc. 340cm bkt

18773

1 pc. 370cm bkt

18774

1 pc. 400cm bkt

18775

1 pc. 450cm bkt

18776

1 pc. 490cm bkt

18777

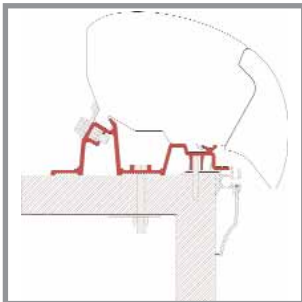

KIT HOBBY PREMIUM

2 pcs. 30cm bkts

2 pcs. 50cm bkts

18761

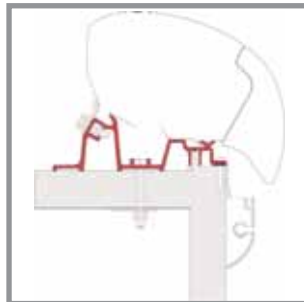

KIT CARAVAN FENDT

4 pcs. 20cm bkts

18758

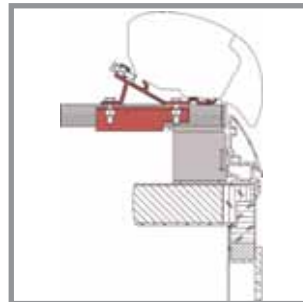

KIT FIAT DUCATO JUMPER / BOXER (HIGH ROOF SUPER LONG)

2 pcs. 26cm bkts

1 pc. 12cm bkt

18729

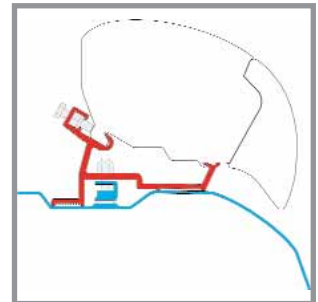

KIT HOBBY 2009

2 pcs. 50cm bkts

2 pcs. 30cm bkts

18759

CARAVANSTORE



DELUXE GREY



BLUE OCEAN

The caravan awning from Fiamma. The first easy to use, sturdy and lightweight bag awning.

The Fiamma Caravanstore® is easy to use and install, it takes only seconds to roll it out completely. Simple and essential, Fiamma Caravanstore offers excellent shelter from the sun.

This years version is new and improved and has dual lead bar rails.

Caravanstore 190cm Blue Ocean	23560
Caravanstore 190cm Deluxe Grey	23562
Caravanstore 225 Blue Ocean	23564
Caravanstore 225 Deluxe Grey	23566
Caravanstore 255 Blue Ocean	23568
Caravanstore 255 Deluxe Grey	23570
Caravanstore 280 Blue Ocean	23572
Caravanstore 280 Deluxe Grey	23574
Caravanstore 310 Blue Ocean	23576
Caravanstore 310 Deluxe Grey	23578
Caravanstore 360 Blue Ocean	23580
Caravanstore 360 Deluxe Grey	23582
Caravanstore 410* Blue Ocean	23584
Caravanstore 410* Deluxe Grey	23586
Caravanstore 440** Blue Ocean	23588
Caravanstore 440** Deluxe Grey	23590

CARAVANSTORE ZIPS



Double your living space with the Caravanstore Zip



DELUXE GREY



BLUE OCEAN

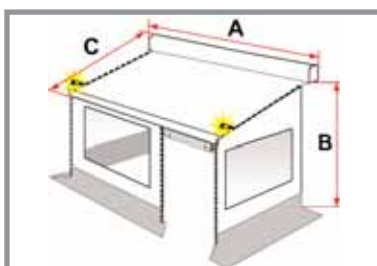

New optional side panel with door

The Caravanstore Zip is the only bag awning complete with windproof and waterproof fasteners. The Caravanstore Zip comes with awning and closure. The innovative Zip system joins the side panels to the awning's fabric with two special sturdy YKK zips. It takes only minutes to make the canopy into a complete Zip privacy room. Delivered as standard with: one front panel with door (door is interchangeable so can be fitted on the LH or RH side), two side panels with screened windows on all items, enabling full ventilation. The Caravanstore Zip also comes with Rapid Set CS, Curtains for all windows and Mega Bag. This years model now has a 2nd lead bar rail giving the user multiple options.

CARAVNSTORE ZIP TOP

- Caravanstore Zip Top 280 Deluxe Grey **23677**
- Caravanstore Zip Top 280 Blue Ocean **23676**
- Caravanstore Zip Top 310 Deluxe Grey **23679**
- Caravanstore Zip Top 310 Blue Ocean **23678**
- Caravanstore Zip Top 360 Deluxe Grey **23681**
- Caravanstore Zip Top 360 Blue Ocean **23680**
- Caravanstore Zip Top 410 Deluxe Grey **23683**
- Caravanstore Zip Top 410 Blue Ocean **23682**
- Caravanstore Zip Top 440 Deluxe Grey **23685**
- Caravanstore Zip Top 440 Blue Ocean **23684**

CARAVANSTORE ZIP PRIVACY

- Caravanstore 280 Zip Privacy Room **23686**
- Caravanstore 310 Zip Privacy Room **23687**
- Caravanstore 360 Zip Privacy Room **23688**
- Caravanstore 410 Zip Privacy Room **23689**
- Caravanstore 440 Zip Privacy Room **23690**

Awning Length A	Height from Ground B	Extension C	Weight
288cm	240-260cm	225cm	24.2KG
318cm	240-260cm	225cm	26.1KG
369cm*	240-260cm	225cm	28.8KG
419cm*	240-260cm	225cm	31.9KG
449cm**	240-260cm	225cm	34.5KG

***Delivered with Caravanstore Support Leg**
****Rafter Caravanstore & Caravanstore support leg included.**

When measuring up for a Caravanstore Zip or for a Privacy Room CS Light for a Caravanstore – please refer to the diagram and charts above.

SUNSTORE



New ultra-light awning for caravans, it can be easily dismantled and takes up very little space when travelling. Simplified version of Caravanstore; dismantled, the frontal tube is divided in two pieces and it's easy to put back inside the caravan.

SUNSTORE 260 PEARL GREY	23600
SUNSTORE 290 PEARL GREY	23602
SUNSTORE 340 PEARL GREY	23604

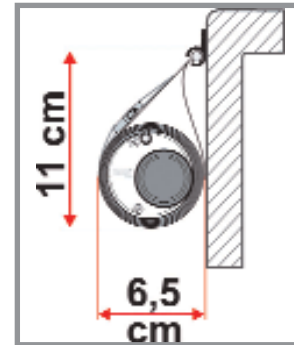
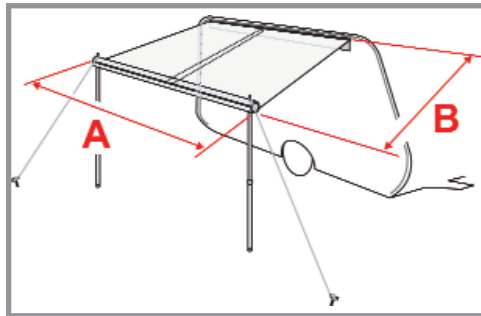

CARAVANSTORE PRIVACY CS LIGHT



The new and improved version of the Fiamma Caravanstore Privacy Room CS Light is lighter in weight and also lighter in price. All front and sides now have ventilation. Suitable for all models of Caravanstore from 2004.

Privacy Room CS Light 280cm	23752
Privacy Room CS Light 310cm	23754
Privacy Room CS Light 360cm	23755
Privacy Room CS Light 410cm	23756
Privacy Room CS Light 440cm	23757



The Caravanstore Privacy Room CS Light is delivered as standard with 1 front panel, 2 side panels, Fast Clip installation kit, Curtain Kit Ocean for the front window and Mega Bag Light.

PATIO-MAT

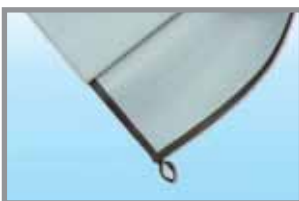

The Patio-Mat from Fiamma is an essential accessory for your Fiammastor and Privacy Room. Lightweight and easy to fold. Patio-Bag is optional.

PATIO-MAT 290	30050
PATIO-MAT 340	30051
PATIO-MAT 390	30052
PATIO-MAT 440	30053
PATIO-BAG (holds all sizes of Patio Mat)	30056



BLOCKER PRO CARAVANSTORE - F35 (A)



BLOCKER PRO & SIDE W PRO COMBINED

Front panel is equipped with one large full light crystal window and vinyl extension to the floor. Gives you more protection against wind. Made of anti-rot vinyl, washable fabric with UV protection. Simple to install using elastic hooks and pegs provided.

BLOCKER PRO 255	20630
BLOCKER PRO 280	20631
BLOCKER PRO 310	20632
BLOCKER PRO 360	20634
BLOCKER PRO 410	20636
BLOCKER PRO 440	20638

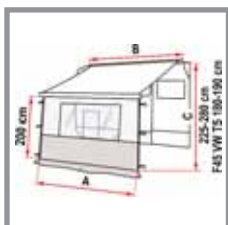

A



B

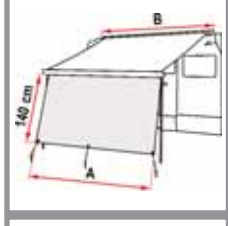

C

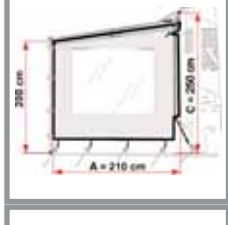

D

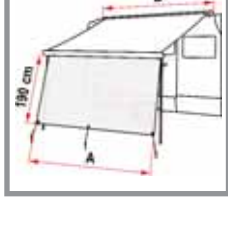

E

SIDE W PRO CARAVANSTORE - F35 PRO (B)

Convenient side panel with one large full light Crystal window and grey vinyl extension to the floor. Made of rot-proof vinyl, washable fabric with UV protection. Simple to install using the telescopic rafter, elastic hooks and pegs provided.

SIDE W PRO CARAVANSTORE	20663
SIDE W PRO F35 PRO VW T5	22525

BLOCKER (C)

Convenient front panel to protect you from sun light and rain and to give you more privacy. Delivered with ropes and pegs.

BLOCKER 310	20727
BLOCKER 360	20728
BLOCKER 410	20732

SIDE W CARAVANSTORE - F35 PRO (D)

Convenient side panel made of anti-rot vinyl, washable fabric with UV protection. Simple to install using the telescopic rafter, elastic hooks and pegs provided. This item includes window but does not have integrated skirt.

SIDE W CARAVANSTORE	20662
---------------------	--------------

SUN VIEW XL (E)

Convenient front panel made with translucent light filtering material, blocks about 80% of the light. Can be rolled up thanks to the useful fixing clips. Delivered with ropes and pegs.

SUN VIEW XL 310	20560
SUN VIEW XL 360	20562
SUN VIEW XL 410	20564

SHADE



Convenient valence Shade to slide into the groove of your Caravanstore roller tube. It can be installed when your awning is closed. Helps to protect from sun and rain extending the shade surface. Available in 2 colours: Deluxe Grey and Blue Ocean.

Deluxe Grey	20678
Blue Ocean	20680

RAFTER CARAVANSTORE

The versatile pole solution to strengthen your manual awning. Standard delivered with...
Caravanstore/Zip: 440, Side, Side W and Side W Pro Caravanstore.
Optional for: Caravanstore: 255 to 360cm
F35 Pro: 250 to 300M

23670**CARAVANSTORE SUPPORT LEG**

Reinforced legs developed to be fixed to the frontal tube of the Caravanstore to increase resistance. Standard delivered with...
Caravanstore 440, Caravanstore Zip 360 to 440cm
Optional for all other lengths.

23672**KIT AWNING PEGS**

New range of screw pegs, ideal for awnings, enclosures and mats. Made of tough plastic UV resistant material. You can screw them in the ground manually by using the standard delivered proper key, or connecting them to an electric screwdriver. Kits comprises of 8 Awning Peg stakes 20cm long, 8 Awning Peg stakes 14cm long, 8 hooks, 1 handle, 2 awning plates and elegant carry bag.

29206**KIT AWNING PLATE**

Ideal for fixing the front legs to the ground, in order to increase the resistance in case of strong wind and to protect the legs. Delivered with pegs and suitable for Fiamma and Omni awning legs. Colour: Platinum. Dimensions: 20 x 20cm. Kit 2 pieces.

29204**MEGA BAG**

Large strong bag, suitable for transporting goods in the storage compartment. Colour: Black / Red. Dimensions: L 140 x W 27 x H 40cm

30046**MEGA BAG LIGHT**

Strong bag in light material, suitable for the Privacy-Room light. Colour: Black / Red. Dimensions: L 140 x W 25 x H 25cm

30045

F35 PRO TITANIUM



The F35 is a manual operation sun canopy made with an anodised aluminium case. Suitable for minivans, 4x4s, utility vehicles and station wagons. The F35 is not delivered with fitting brackets. Simply select the relevant brackets for your vehicle. This year's model now has a 2nd lead bar guide rail.



Anodised aluminium case

- | | |
|-----------------------------------|--------------|
| F35 PRO 180 DELUXE GREY | 22485 |
| F35 PRO 180 BLUE OCEAN | 22484 |
| F35 PRO 220 DELUXE GREY | 22490 |
| F35 PRO 220 BLUE OCEAN | 22489 |
| F35 PRO 250 DELUXE GREY | 22495 |
| F35 PRO 250 BLUE OCEAN | 22494 |
| F35 PRO 270 DELUXE GREY | 22511 |
| F35 PRO 270 DEEP BLACK NEW | 22515 |
| F35 PRO 270 BLUE OCEAN | 22510 |
| F35 PRO 300 DELUXE GREY | 22521 |
| F35 PRO 300 BLUE OCEAN | 22520 |

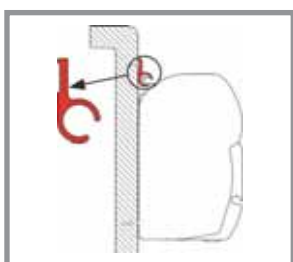

RAIL

1 pc. 300cm Rail **18070**
1 pc. 400cm Rail **18090**

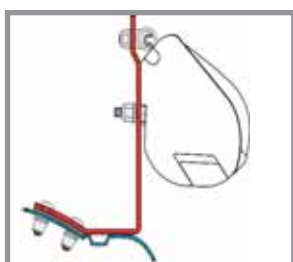

KIT MERCEDES VITO

VITO Marco Polo
2 pcs. 8cm bkts

23060

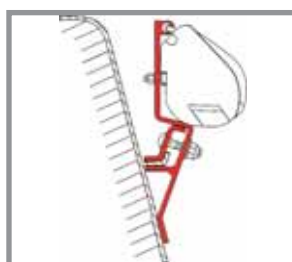

KIT VW T3

2 pcs. 8cm bkts

23030

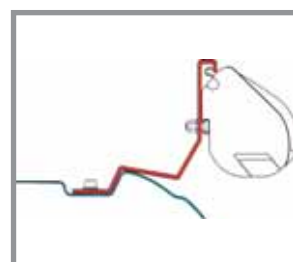

KIT MERCEDES VIANO VIANO MARCO POLO

2 pcs. 13cm bkts

23020

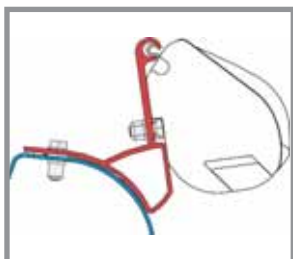

KIT RENAULT TRAFIC OPEL VIVARO NISSAN PRIMASTAR

2 pcs. 12cm bkts

23021

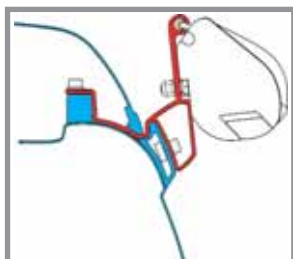

KIT VW T5 CALIFORNIA

2 pcs. 12cm bkts

23024

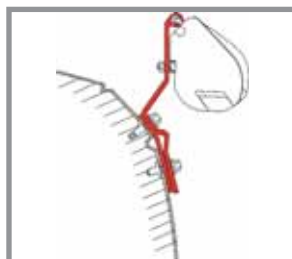

KIT VW T4 LIFT ROOF

2 pcs. 8cm bkts.

23040

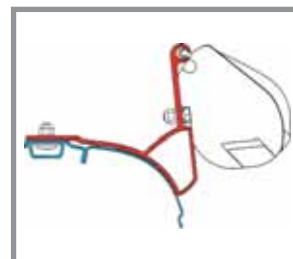

KIT VW T5 MULTIVAN TRANSPORTER

2 pcs. 12cm bkts

For the Transporter version the rail is optional: contact the VW dealer to get the rail.

23022

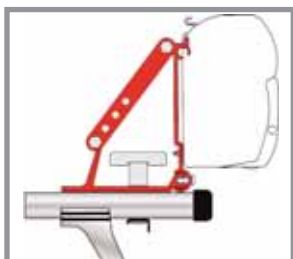

KIT AUTO

Installation on Roof Rails
2 pcs. 8cm bkts

23091



KIT STANDARD

Installation on Roof Rails
2 pcs. 8cm bkts

23050



KIT HOBBY CARAVANSTORE

Supplementary kit to fix the Caravanstore on Hobby caravans, 2009 production, edition 6.

23595

REAR DOOR COVER DUCATO

Enclosure for the rear doors of Fiat Ducato, Citroen Jumper, Peugeot Boxer and Mercedes Sprinter high roof vehicles after 06/2006

Quick and easy to install. Rear Door Cover Ducato is supplied with side panels and front enclosure that can be rolled up to grant more privacy. The upper rafter and rail keep the fabric tight. The double rail is attached to the Ducato gutter, whilst the aluminium rafter blocks the opening of the two rear doors, keeping the fabric tight. The door can be rolled up.

**Delivered as standard with:**

Double Rail
Awning with side and front panels
Rafter to increase stability
Kit of tension elastic ropes

REAR DOOR DUCATO **22470**
KIT POLES (OPTIONAL)* **22476**
*Pair of aluminium poles for extending the door in to an additional canopy.

REAR DOOR COVER VW T5

Enclosure for lift up tailgate version of the VW T5 vehicle.

Quick installation. Can be fitted to vehicles with or without Carry Bike mounted (as long as bikes are not mounted).

Delivered as standard with:

Enclosure with openable door that can be rolled up or extended.
Equipped with mosquito screen.
Set of floor poles
Kit of tension elastic ropes
Pegs

REAR DOOR COVER VW T5 **22472**
KIT POLES (OPTIONAL)* **22476**
*Pair of aluminium poles for extending the door in to an additional canopy.

REAR SKIRTING DUCATO

Special version of Fiamma skirt designed to protect against wind and rain for the rear doors of Fiat Ducato.

21366**REAR SKIRTING VW T5**

Special version of Fiamma skirt designed to protect against wind and rain for the rear doors of VW T5

21365

CARRY BIKE PRO C



Fiamma's number one seller. Can carry up to 4 bikes in total. Standard delivered to carry 2 bikes with 2 x Quick Rails, 1 x Bike Block Pro 1 and 1 x Bike Block Pro 3.

also available in **Blue**

12120
12123

CARRY BIKE PRO C N



Carry Bike Pro rack but the "N" version does not come with any top or bottom fixings. Many Motorhomes on the market such as the ones made by Bailey or CI come with preinstalled brackets on them. As the brackets are not included in with this rack, it's cheaper as a result.

12121

CARRY BIKE PRO



Another huge selling Carry Bike. Can carry up to 4 bikes in total. Normally fits above and below rear windows. Standard delivered with 2 x Quick Rails, 1 x Bike Block Pro 1 and 1 x Bike Block Pro 3.

12110

CARRY BIKE PRO N



Carry Bike Pro rack but the "N" version does not come with any top or bottom fixings. Many Motorhomes on the market such as the ones made by Bailey or CI come with preinstalled brackets on them. As the brackets are not included in with this rack, it's cheaper as a result.

12111

CARRY BIKE UL



Similar spec to Carry Bike Pro but carries a maximum of 3 bikes. Standard delivered with 2 x Quick Rails and 1 x Bike Block Pro 3.

12173

CARRY BIKE CL



Similar spec to Carry Bike Pro C but carries a maximum of 3 bikes. Standard delivered with 2 x Quick Rails and 1 x Bike Block Pro 3.

12193

CARRY BIKE PRO HYMER - DETHLEFFS



Carry Bike in Blue for Hymer motorhomes with pre-installed upper fixing brackets. Can carry a maximum of 4 bikes. Standard delivered with 2 x Quick Rails, 1 x Bike Block Pro 1 and 1 x Bike Block Pro 3.

Hymer Adaptor Kit (for vehicles which need brackets)

Kit Dethleffs (before 2010)

Kit Dethleffs (after 2010)

11521

14928

14865

14866

CARRY BIKE PRO C KNAUS - EIFFELAND

Special version of Carry Bike Pro C with entire upper structure, suitable for Knaus motorhomes and Eiffeland Caravans. Standard delivered with 2 x Quick Rails, 1 x Bike Block Pro 1 and 1 x Bike Block Pro 3.

12140**CARRY BIKE L80 - LAIKA**

Special version of Carry Bike Pro C with 80cm wheelbase, suitable for Laika Motorhomes. The only Fiamma Bike Carrier that can cater for Tandem bikes. Standard delivered with 2 x Quick Rails, Bike Block Pro 1 and Bike Block Pro 3.

12280

2M Rail for carrying Tandem Bikes

14510**CARRY BIKE PRO AUTOTRAIL**

Enlarged version of the Carry Bike Pro structure, specially designed for installation on Autotrail Motorhomes from 2011 with spare wheel moulding on rear.

Supplied with Bike Block Pro 1, Bike Block Pro 3 and 2 x Quick Rails.

Has the ability to Carry up to 4 bikes when extra parts are ordered, however speak to an Autotrail dealer before doing so to discuss weight limitations on rear wall of vehicle

12133**CARRY BIKE TRIGANO**

This bike rack is provided with a fixed structure and height of 39.5cm. Comes without fittings and is only suitable for fitting on to CI and Roller Team vehicles which already have the fittings in place on van. Can carry up to 3 bikes maximum. Standard delivered with 2 Quick Rails, 1 x Bike Block Pro 3.

12270**CARRY BIKE LIFT 77**

This bike rack is the only one on the market that has a winch system enabling the bike holding frame to be lowered down as much as 77cm, thus enabling the bikes to be loaded easily. Standard delivered with 2 x Quick Rails, 1 x Bike Block Pro 1 and Bike Block Pro 3. Available in either Red or Blue. Can carry up to 4 Bikes.

Red

12220

Blue

12221**200 DJ BIKE RACK**

Clamp on bike rack designed to fit various vehicles. See Fiamma brochure for full list as some of the bike racks listed below will also fit other vehicles. All 200 DJ racks carry a maximum of 2 bikes. Standard delivered with 2 Rail Premium, Bike Block Pro 1 and Bike Block Pro 2.

Carry bike 200DJ Fiat Ducato before 06/2006

13372

Carry bike 200DJ Fiat Ducato after 06/2006

13375

Carry bike 200DJ Merc Sprinter / VW Crafter after 06/2006

13374

Carry bike 200DJ Renault Master after 06/2010

13379**CARRY BIKE 200D**

Bike carrier for vans with double rear doors. Carries 2 bikes maximum. Can be installed on the following vehicles.

Fiat Ducato before 1999, Peugeot J5 before 1999, Citroen C25 before 1999, Ford Transit, VW LT, VW LT high roof, Mercedes MB 100, Ford Transit high roof, Citroen Jumper, Peugeot Boxer.

Standard delivered with 2 x Rail Premium, 1 x Bike Block Pro 1 and 1 x Bike Block Pro 2.

13360

CARRY BIKE MERCEDES VITO



For models before 2004. Specially made for Mercedes Vito with single rear door. Easy installation with standard delivered brackets. No drilling necessary. Can carry up to 4 bikes. Standard delivered with 2 x Quick Rails, 1 x Bike Block Pro 1 and Bike Block Pro 3.

13350

CARRY BIKE VIANO



Specially designed for Mercedes Viano with single rear door. Easy installation with standard delivered brackets. No drilling necessary. Can carry up to 3 bikes. Standard delivered with 2 x Quick Rails, 1 x Bike Block Pro 1 and Bike Block Pro 3.

13352

CARRY BIKE OPEL VIVARO / RENAULT TRAFIC



Specially designed for Open Vivaro and Renault Trafic vehicles with single rear door. Easy installation with standard delivered brackets. No drilling necessary. Can carry up to 4 bikes. Standard delivered with 2 x Quick Rails, 1 x Bike Block Pro 1 and Bike Block Pro 3.

13316

CARRY BIKE FOR TRANSIT



Specially designed for Ford Transit with single rear door. Easy installation with standard delivered brackets. No drilling necessary. Can carry up to 3 bikes. Standard delivered with 2 x Quick Rails, 1 x Bike Block Pro 1 and 1 x Bike Block Pro 3.

13332

CARRY BIKE RENAULT TRAFIC D



Specially designed for Renault Trafic / Opel Vivaro vehicles with double rear doors. No drilling necessary. Carries 2 bikes. Standard delivered with 2 x Premium Rails, 1 x Bike Block Pro 1 and 1 x Bike Block Pro 2.

13319

CARRY BIKE BACKPACK PRO



Suitable for most mini van type vehicles. Easily adaptable, with adjustable webbing straps. No drilling required with installation. Carries up to 3 bikes. Standard delivered with 2 x Quick Rail Cs, 1 x Bike Block Pro 1 and Bike Block Pro 3.

13910

LICENCE PLATE CARRIER



Number plate holder bar with regulation lights. Ideal to be installed to Carry Bikes fitted to vehicles with double rear doors (when the rail support covers the lights and the number plate of the vehicle). Dimensions: 131 x 16.5 x 7.5cm

14785

CARRY BIKE VW T5



Specially designed for Volkswagen T5 with single rear door. Easy installation with the standard delivered brackets, no drilling on vehicle necessary. Can carry up to 4 bikes. Standard delivered with 2 x Quick Rails, 1 x Bike Block Pro 1 and 1 x Bike Block Pro 3.

13312

CARRY BIKE VW T4



Specially designed for Volkswagen T4 with single rear door. Easy installation with the standard delivered brackets, no drilling on vehicle necessary. Can carry up to 4 bikes. Standard delivered with 2 x Quick Rails, 1 x Bike Block Pro 1 and 1 x Bike Block Pro 3.

13310

CARRY BIKE VW T4D



Specially designed for Volkswagen T4D with double rear door. Easy installation with the standard delivered brackets, no drilling on vehicle necessary. Carries a maximum of 2 bikes. Standard delivered with 2 x Rail Premium, 1 x Bike Block Pro 1 and 1 x Bike Block Pro 2.

13340

CARRY BIKE VW T5D



Specially designed for Volkswagen T5D with double rear door. Easy installation with the standard delivered brackets, no drilling on vehicle necessary. Carries a maximum of 2 bikes. Standard delivered with 2 x Rail Premium, 1 x Bike Block Pro 1 and 1 x Bike Block Pro 2.

13344

CARRY BIKE VW T3 (T25)



Specially designed for Volkswagen T3 (T25). Easy installation with the standard delivered brackets, no drilling on vehicle necessary. Standard delivered with 2 x Quick Rails, 1 x Bike Block Pro 1 and 1 x Bike Block Pro 3.

13300

CARRY BIKE VW T2



Specially designed for Volkswagen T2. Easy installation with the standard delivered brackets, no drilling on vehicle necessary. Standard delivered with 2 x Quick Rails, 1 x Bike Block Pro 1 and Bike Block Pro 3.

13290

CARRY BIKE XLA

Fits all caravans with standard A frame, Hobby type with extended frame and new Alko frame. Carries 2 bikes. No drilling required. Bikes must be removed in order to tilt bike rack to get in gas bottle locker. Standard delivered with 2 x Quick Rails and 2 x fastening strips to fix the bikes.

12770**CARRY BIKE CARAVAN XL A PRO 200**

Similar to Caravan XLA bike rack but this rack can be tilted forwards with the bikes mounted in order to get in to gas bottle locker. This year's version is new and improved. Carries 2 bikes. Delivered as standard with 1 x Quick Rail, 1 x 2 part rail and fastening strip to fasten the first bike and 1 x Bike Block Pro 2.

12785**CARRY BIKE XLA PRO**

Similar to XLA Pro 200 (above) but carries up to 3 bikes. Comes standard delivered to carry 2 bikes. Bike rack can be tilted forward with bikes mounted. Standard delivered with 1x Quick Rail and 1 x 2 part rail and 1 x fastening strip to secure the first bike.

12782**CARRY BIKE SIMPLE PLUS**

Suitable for mounting on caravans with weak and curved rear walls. Installed by using the existing wall's reinforcement points. The upper brackets are positioned in the rail over the window. Carries 2 bikes. Standard delivered with 2 x Quick Rails, Bike Block Pro 1 and Bike Block Pro 2.

12790**CARRY BIKE CARAVAN UNIVERSAL**

Fixes to the caravan frame. (Burstner, Chateau, etc.). Upper and lower brackets are installed by using self tapping screws. Telescopic frame. Adjustable from 100 to 180cm. Carries 2 bikes. Supplied with Bike Block Pro 1 and Bike Block Pro 2.

12801**CARRY BIKE CARAVAN HOBBY**

Suitable for mounting on the rear wall of Hobby caravans produced after 2003. The upper brackets supplied are positioned under the rail of the rear window.

The standard delivered lower fixing kit is a central bracket.

Can carry up to 3 bikes. Standard delivered with 2 x Quick rails and Bike Block Pro 3.

12803

CARRY-MOTO



Motorbike carrier for motorhomes with garage facility. Consists of a rail (length:202cm, internal width: 14cm) and a chute (length: 180cm) which easily slides in to connect with the rail to facilitate the loading of the motorbike. Made of sturdy galvanised aluminium. Carries up to 200KG.

14434

CARRY MOTO PRO



New carry moto system, comprises of two telescopic aluminium rails. Ideal for installation in to the garage facility of your motorhome. Consists of a rail that fixes to the floor of garage (180cm long – 15cm wide) and a chute which slides easily inside of the fixed rail (155cm long). The rail is supplied with two sturdy straps to fix motorbike while travelling. It can carry up to 200KG.

13956

CARRY RAMP



New motorbike carrier for all motorhomes with garage facility. Consists of ramp made from galvanised aluminium that can be installed inside of the door of your motorhome or on to the floor of the garage facility. Once the fixed plate is installed on the floor the ramp can be easily hooked or unhooked. Standard delivered with bag. Rail extends up to 175cm long. Internal width of each rail is 15cm. Holds up to 130KG.

13957

ROLL ON RAMP

To receive what was known in the past as a roll on ramp please order

2 X 13957

MOTO WHEEL CHOCK FRONT (A)



The perfect way to keep your Moped / Motorbike steady during transit. Made from black anodised steel. Easy to assemble and remove thanks to its 4 screw anchor holes. Package also included 2 click strips and kit for fixing to wood floors.

14399

MOTOR WHEEL CHOCK REAR (B)*

14400

*Similar to the Front Wheel Chock but has quick removal knobs.

CARRY BIKE GARAGE STANDARD



Bike carrier with lower section that fastens to the floor, Bike Block fixes to the wall or to the roof. Carries up to 3 bikes. Delivered with 2 Rail Strips, 1 Bike Block Pro 1 and 1 x Bike Block Pro 3.

12240

CARRY BIKE GARAGE PLUS



Bike carrier for motorhomes with garage facility. Similar spec to the Garage Standard as above but can carry up to 4 bikes. Delivered with 2 Rail Strips, 1 x Bike Block Pro 1 and 1 x Bike Block Pro 3.

12248

BIKE BLOCK PRO



Min. 12.5 cm - max 15.5 cm



Min. 23 cm - max 26 cm



Min. 38 cm max 41 cm



Min. 53.5 cm - max 56.5 cm

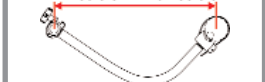

The strongest, quickest and safest blocking system for bikes. The quick front clasp with its large non-scratch base fits round and oval bike tubes with diameters from 25mm to 80mm. Suitable for all Carry-Bike models.

Bike Block Pro 1 Red	14580
Bike Block Pro 1 Blue	14581
Bike Block Pro 1 Black	14582
Bike Block Pro 2 Grey	14593
Bike Block Pro 2 Red	14590
Bike Block Pro 2 Blue	14591
Bike Block Pro 2 Black	14592
Bike Block Pro 3 Red	14600
Bike Block Pro 3 Blue	14601
Bike Block Pro 3 Black	14602
Bike Block Pro 4 Red	14610
Bike Block Pro 4 Blue	14611
Bike Block Pro 4 Black	14612

BIKE BLOCK PRO D



Min. 10 cm - max 42 cm



Min. 16 cm - max 63 cm



Can be adjusted in many positions.

Bike Block Pro D1	14616
Bike Block Pro D2	14617

BIKE COVER S



In reinforced polyester material. It is lightweight and water-proof. It adapts to any load size thanks to its adjustable straps. Standard delivered with transparent pocket to insert the rear signal plate. Not suitable for bike racks where the bikes are exposed over the top of the roof.

Bike Cover S 2/3 bikes	14741
Bike Cover S 4 bikes	14751

BIKE COVER PREMIUM S



Version of the Bike Cover Premium with self-lubricating side zippers and Velcro. Forms a complete enclosure around the bikes. Keeps your bicycles clean while travelling. It is made of extra strong polyester. Standard delivered with transparent pocket to insert the rear signal plate. One size covers up to 4 bikes. Not suitable for offset bike racks.

14763

BIKE COVER CARAVAN



Bike cover with K way system, special version to cover bikes on Carry Bike Caravan XLA and XLA Pro 300 bikes. In reinforced polyester material. Carries up to 2 bikes. Colour: Grey

14760

RAIL QUICK



The traditional Fiamma bike rail. As used on the majority of their bike racks.

- Rail Quick 128 Red 14470
- Rail Quick 128 Blue 14480
- Rail Quick Red 140cm – Only for L80 14500
- Rail Quick Red 200cm – Only for L80 14510

RAIL PREMIUM



Solid and robust supplementary 128cm rail on an improved structure complete with sliding wedges and strip belt to easily fasten the wheels of the bike.

Colour Grey. 14534

RAIL PREMIUM E BIKE

Similar Rail Premium but is 139cm long. 14536

RAIL PREMIUM S



New elegant rail with increased structure, 128cm long.

The rail runs along the Carry Bike rail support, the wheelbase among the bikes is adjustable both ways enabling you to easily and perfectly place your bikes. The fixing system to the carry structure is made by solid bolts, easy to adjust, that do not require drilling of the tube. Complete with sliding wedges and incorporated Quick straps to easily fasten the wheels of the bike. 14535

KIT PREMIUM S

Kit of 2 hooks that allows to convert Rail Quick and Rail Premium into Rail Premium S. 14538

RAIL STRIP



Similar to Rail Quick but with red straps for fastening instead of Quick Safes.

Rail Strip Red 128cm 14440

RAIL QUICK C



Telescopic rail that can be adjusted to the desired extension, supplied with 2 Quick-Safe straps. Ideal to limit rail overhang.

- Rail Quick C Red 14530
- Rail Quick C Black 14532

BIKE FRAME ADAPTOR

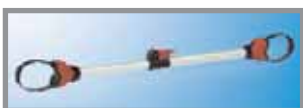

Frame adaptor for easy fitting to bikes with non-standard frame ie. ladies bikes and BMX's. 14618

QUICK SAFE (1 PC)



- STRIP KIT RED (PR)** 14680
- For securing bike to rails – 39cm long 14620

STRIP KIT BLACK (PR) 14619

SECURITY STRIP 2MTRS 14650
2M long strap - 1pc. 13mm wide.

PLASTIC SIGNAL

Dimensions: 50cm x 50cm

14780

ALUMINIUM SIGNAL

Rear signal plate for protruding loads, easily fits to motorcaravans, vans and 4 wheel drive vehicles. Made from lightweight aluminium.

Dimensions: 50cm x 50cm

14770

**FIXING BAR CARRY BIKE**

Pair of reinforcement bars (2.4M Long) to mount the Carry Bike where rear walls are weak.

14932

CABLE LOCK

Handy anti-theft cable made of black plastic-coated steel with incorporated padlock. Standard delivered with 2 keys. 2.5M Long.

14820

KIT SUPPORT BAR

Kit of 2 perforated smart bars to fix the Carry-Bike on the walls of Motorhomes. Made of sturdy and light anodised aluminium. Complete with screws, internal fixing brackets and end caps. Dimensions: 74 x 4cm.

14934

KIT CARRY BOX

Holder rail carrier designed for a quick installation on Fiamma Carry Bike Pro line racks. Unscrewing the two screws you can replace the carry bike rail carrier with the Kit Carry Box. Ideal to carry cumbersome materials. It carries up to 60KG.

13959

EASY DRY

Drying rack suitable for quick installation on the folding rail support base of Fiamma Carry Bikes and also on to bike carriers of other brands. Tube diameter is 35mm.

14430

RACK HOLDER



For retaining bike rack holding tray in upright position when not in use.

14710

KIT QUICK



For securing bikes with particularly thin wheel rims.

14700

PROTECTION PADS (PAIR)



Foam protection pads for Carry Bikes.

14730

HOBBY ADAPTOR KIT



Adapts to the Hobby Caravan rail. For models before 2003. Sold as a pair.

14860

BURSTNER ADAPTOR KIT



Adapts to Burstner caravans and motorhomes. Sold as a pair.

14870

PLATE XL BOTTOM

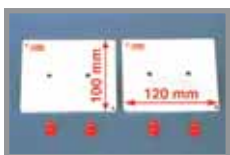

For reinforcing the bottom wall of vehicle when fitting Carry Bike. Kit of 2 plates and 2 cover plates.

14890

HEAVY FIX TOP (PAIR)

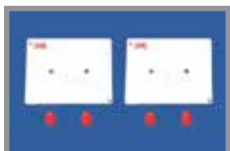

Upper brackets that spread the load of the top brackets on a bike rack.

14880

LONG FIX BOTTOM



Optional heavy duty bracket for better distribution of the load on the wall.

14924

GARAGE SLIDE PRO BIKE

Improved version with wider loading surface. Easy to install multi-use sliding system for the garage facility or storage compartment areas of the motorhome. Only 7.5cm high, adjustable in height from 8cm to 12cm. Patented slide system. The lower rail is screwed into place while the upper rail slides onto the track system thanks to self-lubricating steel nylon coated bearings, mounted with ball bearings. Equipped with safe hook for both positions, closed and open.

**Delivered as standard with:**

Complete Carry Bike structure
2 Strips
4 Sliding wedges – Premium S
2 Protection Pads
For transporting two bikes.

13955**GARAGE-BARS CORNER**

New version of the Garage Bar Premium, but designed specially to be installed in the corner of the garage facility.

Takes up minimal space. Dimensions: 200 x 5 x 5cm

13951**KIT EYE PREMIUM / CORNER**

Kit comprises of 2 quick action connecting hooks with retaining ring. For Garage-Bars Premium and Garage-Bars Corner.

13952**GARAGE BARS PREMIUM**

Version of garage bars designed for easy installation into the garage compartment of motorhomes. It comprises of 2 multi-use bars made from strong anodised aluminium designed to take up minimum room. Each bar includes 2 hooks with eyelets.

Model 200: 200 x 6.6 x 1.3cm

13949

Model 60: 57 x 6.6 x 1.3cm

13950**GARAGE BARS**

The garage bars are 2 bars in anodised aluminium that are fixed to the garage walls, each complete with 5 eye sliding hooks and fixing screws. Dims. 4cm x 2.5cm x 2M.

Garage Bars x 2

13944

Additional Sliding Eyes (2 pcs)

13946**GARAGE PACK**

New Fiamma multi-purpose kit to arrange the garage facility of your motorhome. Simple and flexible modular system.

Kit comprises of:

2 aluminium bars 63cm

1 aluminium bar 198cm

2 reinforced rails

2 galvanised rings

1 strip 200cm

13995

GARAGE SYSTEM STANDARD (A)



Very practical system to arrange the garage facility of even the biggest of motorhomes. Made of tough but light modular anodised aluminium. The standard module (A) is a single stand with 3 shelves to position the optional folding boxes (C) or solid shelves. Aluminium struts are adjustable in height and able to be shortened in case of rear steps or narrow / curves spaces.

13990

GARAGE SYSTEM UPGRADE (B)

The upgrade module is used to enlarge the standard module with a second shelf.

13991

GARAGE SYSTEM SUPPORT (C)

13996

GARAGE BOX (3 PCS) (D)

Set of three folding boxes suitable for the shelves of the Garage System. Take up little room when folded but very roomy when erected.

13992

KIT GARAGE WALL BRACKETS

13953



A



B



C



D

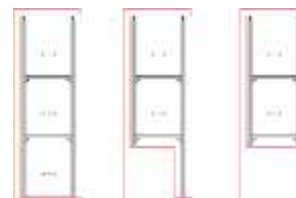

CARGO STRAP



Strong fixing system to block (or to strap) objects such as: small tables, chairs, spare wheel etc. into the boot or garage of your camper. Delivered with 2 x ABS wall tracks, 4 hooks, 2 rubber bands and 24 fixing screws.

CARGO STRAP
CARGO ACCESSORY KIT

13960

13961

GARAGE SLIDE PRO SKI



Sliding ski rack for the garage of your motorhome which comprises of:
1 x ABS high quality case
2 x Aluminium slide guides that you can slide out up to 1M.
The lower rail is screwed into place, adjustable in height from 0 to 4cm, the case slides easily even when fully loaded thanks to the nylon-coated steel wheels.

Dimensions: 200x 47 x 14.4cm

Weight: 11KG

13938

KIT SQUARE PLATES



Stainless steel securing hooks to be applied to garage floor. 4 pcs in kit. Dims: 3.5 x 3 x 2cm

13948

TOP BOX



Superior quality boxes for your motorhome with completely reinforced aluminium structure and watertight foam seal. Made from top quality ABS-Plus, highly resistant to weather conditions, with co-extruded high thickness UV protection to prevent deterioration of quality with age. Complete with installation brackets and rust-proof stainless steel hinges. Colour: Polar White

ULTRA BOX 2 TOP - 400L Capacity – Weight 13KG **24730**
 ULTRA BOX 3 TOP - 520L Capacity – Weight 17KG **24740**

BOX 320



Compact rear luggage box that can attach directly on to the rear of a motorhome (when using Wall Fit Kit) or on to a bike rack, by making use of the standard delivered brackets. Capacity 320L – Weight 12KG **24180**

BOX 360



Compact rear luggage box that can attach directly on to the rear of a motorhome (when using Wall Fit Kit) or on to a bike rack, by making use of the standard delivered brackets. Capacity 360L – Weight 14KG **24190**

BOX 500



Compact rear luggage box that can attach directly on to the rear of a motorhome (when using Wall Fit Kit) or on to a bike rack, by making use of the standard delivered brackets. Capacity 500L – Weight 17KG **24170**

WALL KIT BOX



For mounting Back Boxes directly on to the back of vehicles instead of on to a Carry Bike. **24820**

CARGO BACK



A soft luggage bag made from sturdy anti-rip reinforced nylon. Ideal for transporting chairs and camping or sports equipment. Water resistant thanks to the nylon YKK zippers. Dimensions open 120 x 70 x 35cm

KIT FRAME CARGO BACK **24220**
 Optional item that gives Cargo Back more rigidity. **24222**

PACK 610S



New and practical folding bag for garage and the shelf of the Slide 460 which enables organised storage of camping, sport and travel gear. It is made of strong waterproof material. Standard delivered with adjustable straps, handles and exterior pockets. Dimensions when open: 60 x 36 x 31cm. Colour: Grey / Red / Black. Capacity 66L **13963**

PACK AWAY

Fiamma organiser to help optimise space inside the vehicle.
Pack Away is for objects (max 10KG) in the garage of the motorhome.

13978**PACK ORGANISER L**

Fiamma organiser to help optimise space inside the vehicle.
Pack Organiser L is useful for storage of smaller items.

13972**PACK ORGANISER S**

Fiamma organiser to help optimise space inside the vehicle.
Pack Organiser S is useful for storage of smaller items.

13970**PACK ORGANISER SEAT**

Attached to either passenger or driver seat. Useful for storage of smaller items.

13975**PACK ORGANISER SHOES**

For storing shoes either inside the vehicle or the garage area.

13976**PACK ORGANISER TOILETRY**

Organiser for storing bathroom items.

13977**FIX ORGANISER**

Fix organiser is a pair of brackets that can be used as a means of attaching many of the above organiser systems.

13973

CARRY-KAYAK



Ideal to carry canoes, kayaks and surfboards on your vehicle. Kit of 2 brackets. Compact but easy to load thanks to its inclined figure. Made of anodised aluminium and standard delivered with protection pads (complete with fixing straps). Ideal to be fitted on Fiamma Roof Rail with Fixing Bar rails, also suitable for some types of car luggage-carriers. **14432**

ROOF RAIL



Luggage carrier system comprises of 2 perimetric bars easy to install on motorhomes and caravans. Elegant and modern design. Solid terminals (A) are built in aluminium pressure die-casting. The tubes are 3M long and can be shortened. **27942**

FIXING BAR RAIL (PR)



Carry-all bar created from aluminium extrusion 240cm long and easy to shorten. Can be used with Roof Rail (**27942**), Roof Rail Pro 3 (**27945**), and Roof Rail Pro 4 (**27946**). Package includes 2 bars, each with 2 fixing terminals in aluminium pressure die-casting and 2 rubber spacers. **27944**

FIXING BAR RAIL WHITE (PR) **27950**

ROOF RAIL PRO 3



Luggage rack consisting of 3 bars (each 240cm long) and relative corner joints. Rack is made of anodised aluminium. Can be used with fixing bar rail 27944. **27945**

ROOF RAIL PRO 3 WHITE **27947**

ROOF RAIL PRO 4



Luggage rack consisting of 4 bars (each 240cm long) and relative corner joints. Rack is made of anodised aluminium. Can be used with fixing bar rail 27944. **27946**

ROOF RAIL PRO 4 WHITE **27948**

ROOF RAIL DUCATO



Luggage carrier system specially designed for the Fiat Ducato after 06/2006. Either long or short wheel base (shortening the bars). Easy installation without drilling the vehicle, thanks to the preinstalled fixing system on the roof of the Ducato. **27943**

ROOF RAIL DUCATO MAXI XL



Roof rail system for the Maxi Ducato after 06/2006. Easy installation without drilling the vehicle. Delivered as standard with 4 fixing bar rails. **27949**

KIT ROOF RAIL DUCATO COVER LEFT **27890**

KIT ROOF RAIL DUCATO RIGHT **27891**

KIT ROOF RAIL DUCATO EXTRA **27892**

KIT ROOF RAIL DUCATO EXTRA COVER **27889**

FIXING BAR PRO L



The aluminium fixing bar 240cm can be shortened to the required length. Kit includes 1 bar and 2 white end caps. To be placed on the motorhome or caravan roof. Makes ideal support system for solar panels or roof boxes. **27901**

DELUXE 8 FOLDING LADDER



Sturdy lightweight exterior ladder with 8 steps. 30mm diameter and 2mm thick tubes in anodised aluminium. Inside width: 24cm. Total step width: 31cm. Non-skid steps. It can be folded up whilst travelling.

28081

DELUXE 5D FOLDING LADDER

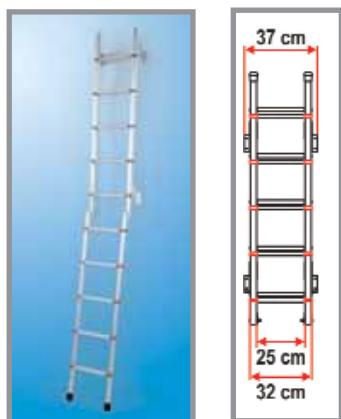

High quality exterior ladder in anodised aluminium with 10 steps. Inside width: 24cm. Total step width: 31cm. Non-skid steps. It can be folded up whilst travelling.

28042

DELUXE 5 LADDER

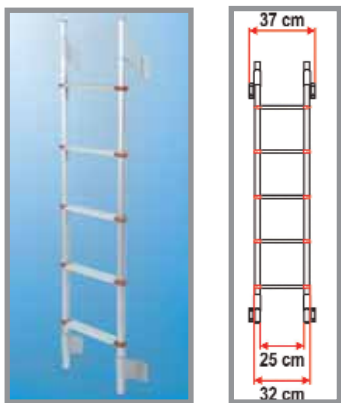

Exterior ladder with 5 steps in anodised aluminium. Inside width: 24cm. Total step width: 31cm. Non-skid steps.

28046

DELUXE 6 LADDER



Exterior ladder with 6 steps in anodised aluminium. Delivered with wall brackets for quick and easy installation. Inside width: 24cm. Total step width: 31cm. Non-skid steps.

28052

DELUXE DJ

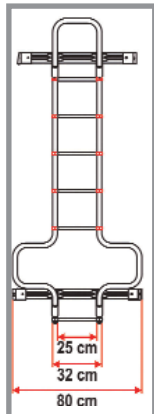

High quality exterior aluminium ladder. Supplied with Fixing bars for quick and easy installation on the left side of the rear door. Can be combined with Carry Bike 200DJ.

Deluxe DJ Ducato after 06/2006

28049

SAFE LADDER



Sturdy anti-theft plate for your motorhome ladder. Suitable for single and double steps. Standard delivered with lock and keys.
Dimension: 23 x 78cm

28090

DELUXE 5B INTERNAL BUNK LADDER

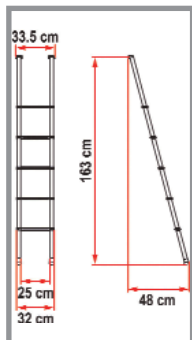

Aluminium ladder with 5 steps with 15° inclination for the inside of luton overcab models of motorcaravan or caravans with bunks.
Inside width: 24cm. Total step width: 31cm.

28073

DELUXE 4B INTERNAL BUNK LADDER

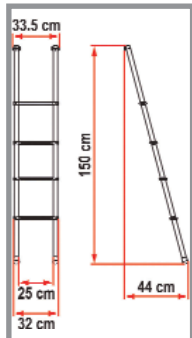

Aluminium ladder with 4 steps with 15° inclination for the inside of luton overcab models of motorcaravan or caravans with bunks.
Inside width: 24cm. Total step width: 31cm.

28062

A) SECURITY HANDLE



A

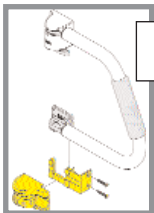

B

Elegant security handle made of solid anodised aluminium with 30mm diameter and 2mm thickness. When closed back on to the door, it works as an anti-theft device and prevents accidental opening when travelling. It also serves as a useful handle to make entering and exiting the vehicle easier. It adapts on to all doors when opening both to the right or to the left. Complete with key lock and safety release handle, installation brackets, screws and internal counter-brackets.

Security 31 White **29460**
 Security 46 White **29470**
 Security 31 Grey **29461**
 Security 46 Grey **29469**

B) KIT SECURITY FRAME

Extra safety kit for Security 31 and Security 46.

Installed on the inside frame of the motorhome or caravan's door.

29475

KIT SECURITY LOCK



Optional safety lock kit for Security 31 and Security 46 to be installed on the door of the motorhome. Comes complete with keys and inside brackets. Made of aluminium.

29473

SECURITY 46 PRO



Special version of Security handle for motorhome doors or for applications where a strong structure is required. Made in light but solid aluminium. Delivered with kit security lock that offers major safety and strength thanks to a third fastening point on the door. Only available in white.

29471

SAFE DOOR MAGNUM



Same features as Safe Door but with the length extended to 20cm in order to cover the locks of the camper doors.

Only available in White.

29532

SAFE DOOR MAGNUM FRAME

Same features as Safe Door Frame but with the length extended to 20cm in order to cover the locks of the camper doors.

Only available in White.

29533

A) SAFE DOOR



A

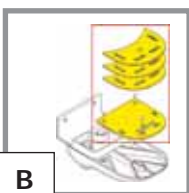

B

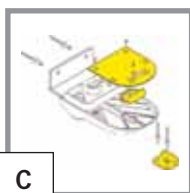

C

Security lock for motorhome and caravan doors.

Made from anodised aluminium without plastic parts.

Safe Door White (bolts through wall of vehicle)

29520

Safe Door 3 White (pack 3, same keys)

29521

Safe Door 3 Grey (pack 3, same keys)

29543

Safe Door Frame White (attaches to door frame)

29522

Safe Door Frame 3 White (pack 3, same keys)

29523

Safe Door Frame 3 Grey (pack 3, same keys)

29524

B) SPACER KIT SAFE DOOR

Spacer to be combined with Safe Door to reduce the gap between motorhome wall and Safe Door.

Spacer Kit White

29518

Spacer Kit Grey

29517

C) KIT SAFE DOOR FRAME MINIVAN

Kit to allow the Safe Door Frame to be installed to the sliding doors of the following minivans: Ducato, Sprinter, Jumper and Boxer.

29525

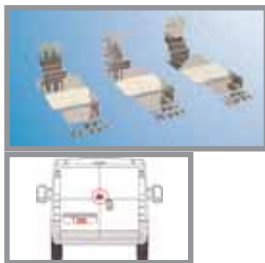
KIT SAFE DOOR DD

Kit composed of steel brackets to allow the Safe Door to be installed on the double doors of the following minivans: Ducato, Jumper, Boxer, Sprinter and Trafic after 06/2006. Easy door installation with screws and rivets included.

Safe Door DD Sprinter >2006	29545
Safe Door DD Ducato/Boxer/Jumper >2006	29546
Safe Door DD Trafic >2006	29547
Safe Door DD Transit >2009	29548

SAFE DOOR GUARDIAN

Security block created to be placed on the inside door or the garage of the motorhome or caravan and to secure the front vehicle doors of the vehicle. 2 pieces in box.

29534**SPACER KIT GUARDIAN**

Optional spacers to align Guardian to the walls. Package includes 10 spacers 1mm each.

29535**SAFE DOOR GUARDIAN SPRINTER**

Similar to the Safe Door Guardian but provided with a bracket especially designed for installation on Mercedes Sprinter doors after 06/2006. 2 pieces in box.

29536**SAFE DOOR GUARDIAN TRANSIT**

Similar to the Safe Door Guardian but provided with a bracket especially designed for installation on Ford Transit doors up to 06/2006. 2 pieces in box.

29537**SAFE DOOR GUARDIAN TRANSIT 06**

For Ford Transits from 06/2006

29539**SAFE DOOR GUARDIAN DUCATO**

Similar to the Safe Door Guardian but provided with a bracket especially designed for installation on Fiat Ducato after 06/2006 - 09/2009. 2 pieces box.

29538**SAFE DOOR GUARDIAN DUCATO**

For Fiat Ducatos from 09/2009

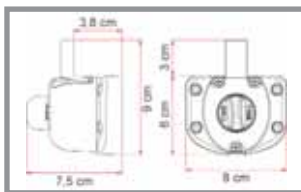
29530**SAFE DOOR GUARDIAN MASTER AFTER 06/2010**

Security locks for installation on cab doors of Renault Master vehicles after 06/2010. 2 pcs in pack.

29528**DUO-SAFE**

Strong security bar allows blocking of front doors from inside. Quick and easy to use. Universal model thanks to the telescopic frame and hooks provided. Suitable for most vehicles, see Fiamma brochure for full list of makes and models.

Antitheft warning label visible from the outside to prevent thefts.

Closed dimensions: 119cm x 18.5cm

29472

TURBO VENT



Turbo Vent is silent at high speed and exceptionally quiet on its low speed. Turbo Vent can be used to bring air in to the vehicle or take air out of the vehicle.

Available in 2 colours and as 2 styles.
 Standard Turbo Vent White
 Standard Turbo Vent Crystal

27111
27113

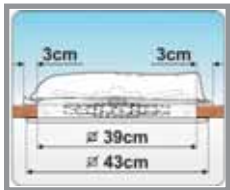

TURBO VENT PREMIUM WHITE



New version of Fiamma Turbo Vent, all functions can be set in motion by simple finger-touch. The new version has a modern design and has a state of the art interface which is finished with brand new multicoloured LED lights. Speed setting and switching now have acceleration ease which helps save the Turbo Vent motor and the vehicle control unit.

27115



TURBO VENT PREMIUM CRYSTAL

Same spec as the Turbo Vent Premium White but with Crystal lid.

27116



VENT 40 X 40



The aerodynamically shaped Roof Vent from Fiamma. Huge seller due to its quality and price.

Vent White
 Vent Crystal

26972
26982

ROLLO VENT 40 LED



New version of roller blind system, with an elegant and innovative design, suitable for Fiamma 40 x 40 rooflights.

Rollo Vent 40 LED
 Rollo Vent (standard model without LEDs)

27082
27081

THERMO VENT 40



Insulated vent shield. Keeps your RV warmer in the winter and cooler in the summer. Suitable for all rooflights 40 x 40cm. The aluminium surface assists by reflecting sunlight and by reducing heat-loss. Dimensions: L40 x W40cm.

27020

TURBO VENT 28



Fresh air for your motorhome's bathroom and kitchen. Rooflight 28 x 28cm, with fan is ideal for airing small spaces.

Turbo Vent 28 White 26906
 Turbo Vent 28 Crystal 26908

VENT 28



The ideal sized vent for kitchens and bathrooms. Rooflight 28 x 28cm. For installation on roofs with depths of max 8.5cm, the optional extension kit can be used.

Vent White 26900
 Vent Crystal 26902

VENT 50 X 50



Wide pantograph rooflight that opens on all four sides. Wide push up handles. (Complete with roller blind system).

Vent White 27051
 Vent Crystal 27052

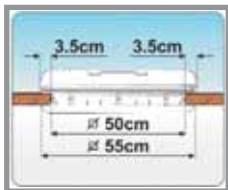

ROLLO VENT 50

Optional roller blind with two rollers, one dark and one with mosquito screen for previous model of Vent 50 x 50cm. Dimensions: 55 x 55cm. Not illustrated.

27070

TURBO KIT



Ventilation system from Fiamma. This kit can be fitted on to many non-vented rooflights to extract air from the motorhome or bring air in to the motorhome. It can be also used as a standalone vent. Compatible with Fiamma 50 x 50 vent, Omni Vent, RemiTop 400, Seitz Mini Heki, Seitz Midi Heki.

26898

SPOILER 40 X 40



The special spoiler assists by channelling the air smoothly around your existing rooflight and thereby reducing both wind resistance and noise levels. It is made of UV-resistant ABS plastic. It is easily installed with the roof vent screws or can be attached with suitable adhesives (Sika).

27010



SPOILER UNIVERSAL

New universal aerodynamic roof spoiler; ideal for reducing vibrations and rooflight noise while travelling. Made with UV resistant PVC material. It can be modified to fit rooflights from 28cm up to 110cm. Dimensions: L 110 x D 20 x 12cm H

20095

EXTENSION KIT FOR ROOFLIGHTS



Universal extension kit for rooflights.

27151

BI-POT

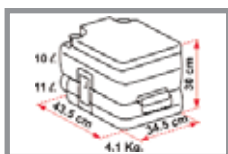

A

SMALL

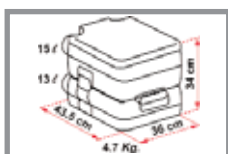

B

MEDIUM

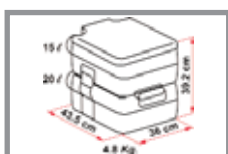

C

LARGE

The new, improved, extremely strong Fiamma portable toilet, available in 3 different sizes. Fiamma Bi-Pot® is a simple, strong self-contained fresh water flush, portable toilet. A very simple system that is both strong and easy to clean. Compact, it can be completely dismantled, including the valve, for thorough and total cleaning. Sturdy and solid handle for easy transportation. Large waste cap: no drainage, emptying is easy and hygienic, no clogging. Each tank is electronically tested for a perfect seal. Handy side clips to connect the upper and lower tanks. Colour: Grey. Bidet available as an optional extra.

- A) Bi-Pot 30 25793
- B) Bi-Pot 34 25781
- C) Bi-Pot 39 25791

HOLD DOWN BRACKETS

Pair of stainless steel hooks to fix the Bi-Pot 30 to the ground. Ideal for minivans and boats.

25794

SOFT 6



Specially formulated 2 ply soft toilet tissue for fixed and portable toilets. Stronger and softer tissue dissolves quickly in water. 300 sheets per roll. 6 roll pack.

26130

SUPER KEM BLUE 2LTR



Disintegrating, deodorising, sanitising, pleasantly scented fluid containing anti-freeze for temperatures to -20°C. Eliminates unpleasant odours. Boxed in 6's. Non-Formaldehyde, Phosphate free, non-irritant fluid. Conforms to European 648-2004 regulation.

26082

SUPER KEM SACHETS



New improved version in sachets for daily use, individually packed in protective packaging. Once opened place the powder in the lower tank and it will dissolve quickly in water with a fresh and pleasant scent of pine oil. One container contains 15 sachets of Super Kem Sachets 30gr each. Tubs are sold in boxes of 6.

26104

SUPER RINSE 1L



For the fresh-water tank of portable and fixed toilets. Super rinse is a scented anti-mildew bactericide that also prevents Algae. Effective rinsing operation. Clean and protects the bowl. Sold in boxes of 10 x 1L bottles. Conforms to European 648-2004 regulation.

26090

TOILET BRUSH

Standard delivered with velcro to be fixed to the inside Bi-Pot cover.
Colour – White

25890**TOILET BRUSH PRO**

New toilet brush and holder designed specially for motorhome bathrooms. Compact, it takes up very little space in the corner of the bathroom.
Large bristle brush cleans efficiently without scratching.
Colour – White.

25891**BIDET UNIVERSAL**

For all Bi-Pot® types; also adapts to Thetford® Porta Potti®, Cassette 1, 2 3 and 4.

25800**BIDET 200**

Only for swivelling cassette 200 Thetford®

25811**AQUA ® 8 PUMPS**

The only self-priming pump with incorporated filter and anti-vibration Silent Plate included.

AQUA 8 12V 7L – 21.75Psi (1.5 Bar)

26400

AQUA 8 12V 10L – 21.75Psi (1.5 Bar)

26420

AQUA 8 12V 7L – 16Psi (1.1 Bar)

26402**AQUA 8 ISENSOR ® NEW**

New version of Fiamma Aqua 8 pump that controls precisely the water pressure of the motorhome and regulates the motor speed, with no need of pressure switches.

26398**A20 EXPANSION TANK**

Eliminates the pulsating operation of pressure switch pumps and supplies a constant flow of water at an even pressure. It is suitable for all pressure switch pumps.

26460

TANKS



ROLL-TANK® 23 W



New practical and portable 23l waste-water tank with total discharge cap. Compact size (fits through normal vehicle doors).
Colour - Grey

26310

ROLL-TANK® 40 W



40l waste-tank with level indicator and air release valve. Filling and discharging are performed through a Sanitary-Flex drain tube (not included). 45° angle adaptor for discharge is included. Same size as Roll-Tank 40F. Colour - Grey

26340

TANK® 21 W



Waste tank with air valve and bayonet connection to the Sanitary-Flex drain tube (not included). Colour - Grey
Dimensions: 50 x 33 x 25cm - Weight - 1.6 kg

26320

TANK FLEX



Drain kit for waste tanks composed of:
1 cap with level indicator
1 flexible hose 30mm diameter, it can be extended to 90cm.
Delivered with threaded cap.

Available in 2 versions

21W with bayonet cap
23W with threaded cap

26353

26354



KIT SANITARY FLEX 75CM



Flexible hose with two fittings. One for connection to Roll Tank 40W, Tank 21W or Tank 18W and the other in stainless steel for connection with the valve of your motorhome. Extendable up to 75cm.

71812

KIT SANITARY FLEX 300CM

71813

QUICK CONNECTION W



New extension to turn the threaded connection into a bayonet connection, to easily connect the Sanitary Flex to the Tank 23 W. Easy to install. Colour: Grey

26356

ROLL-TANK® 23 F



Convenient portable 23l fresh-water tank with total discharge cap. Compact size (fits through normal vehicle doors). Colour – Blue

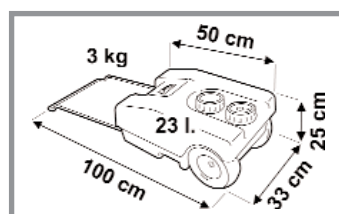

26230

ROLL-TANK® 40 F



Portable 40l drinking-water roll tank with easy grip handle and two large wheels that make transportation easy even on gravel. Made of non-toxic material. Easily cleaned wide cap.

26240

TANK 70L

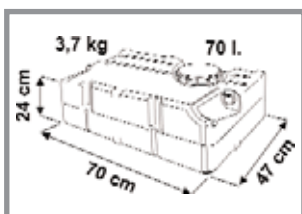
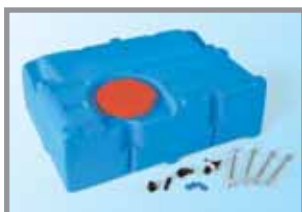

70l fresh-water tank made of non-toxic material. It can be installed either vertically or horizontally. Comes complete with all necessary fittings for installation. Water inlet pipe size ø38mm and air outlet ø13mm.

26260

WATER CAP



Locking cap that complies with European closure system standards. Two colours available.

WATER CAP BLACK

26270

WATER CAP WHITE

26290

POCKET M

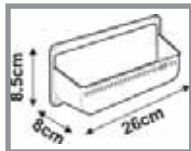

Multipurpose pocket made from scratch resistant plastic, easy to install with the screws provided.
Colour – White

25230

POCKET L

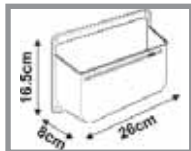

Multipurpose pocket made from scratch resistant plastic, easy to install with screws provided.
Colour – White

25250

POCKET XL

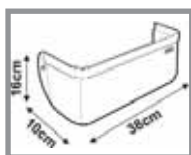

Practical storage pocket that can be easily installed on the vehicle doors or walls with the screws included. In scratch resistant ABS.
Colour – Grey

25270

DISPENSER



Elegant, practical and useful. 0.20l refillable liquid soap or shampoo dispenser. Single chamber dispenser with transparent container. Practical long-lasting push button pump.

29320

POCKET KASSETT

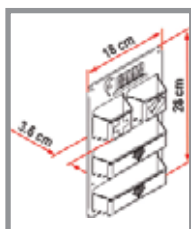

Innovative and useful kit composed of four individual storage pockets to be installed inside the doors of Thetford or Dometic cassette toilets.
Colour – White

25280

PORTA KASSETT



New container for an extra spare Cassette 200 Thetford® toilet tank. Big practical cover facilitates the insertion and extraction of the tank. Made in sturdy shock and weatherproof plastic.

Porta-Kassett
Porta Kassett C250

26140
26141

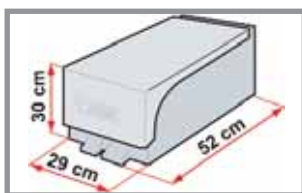

Porta-Kassett

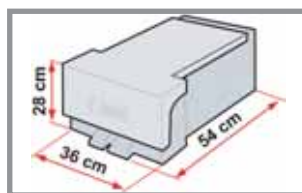

Porta-Kassett C250

LEVEL UP



Keep your motorhome perfectly level. Ridged surface to grip to the vehicle tyres. Lightweight and made in rust-proof material, easy to clean and UV-resistant. Will not crack or break like wood. Level Up can support vehicles with a maximum axle weight of 5 tons. Non-skid finish. Sold in pairs.

LEVEL UP GREY

29114

LEVEL PRO



New innovative design leveller, ideal for caravans. Solid construction in HD UV-resistant polyethylene anti-slip finish. Sold in pairs.

29117

CHOCK LEVEL



The chock (optional) is to be used with either Level Up or Level Pro to secure wheels during long stopovers. Solid construction in UV-resistant HD polyethylene. Each one weighs only 130gr. Sold in pairs.

29131

ANTI SLIP PLATE



New optional anti-slip plate to block the level system on paved surfaces only. Suitable for Level Up, Level Up Jumbo and Level Pro. Dimensions: 100 x 160mm. Sold in pairs.

29132

LEVEL SYSTEM ®MAGNUM



Practical self-locking overlapping system that can raise height. Max axle weight 8 tons. Ideal for motorhomes. Sold in pairs.

29090

GRIP SYSTEM



Anti-skid system with superior traction. Two grips can be combined into one long piece to position under the motorcaravan's wheels. Solid construction in UV-resistant polyethylene. Ideal on sand or mud. Sold in pairs.

29211

LEVEL PLATE

Innovative anti-skid system designed to be easily installed on to the bottom of Fiamma Level Up with the standard delivered screws. It increases the levels of traction, avoiding skids on smooth surfaces and sinking on soft grounds like sand or mud. Solid construction from UV-resistant in PVC.

29140**LEVEL SYSTEM® JUMBO**

Practical self-locking overlapping system that can raise height. Max axle weight 14 tons. Ideal for twin tyres. Sold as pairs.

29100**WHEEL SAVER**

System of cradles that avoid the tyres ovalising. Suitable for wheels up to 70cm diameter. Ideal in case of long parking and garaging. It is possible to fix the cradles on the floor of the garage in order to have a fixed position of parking. Sold as pairs. Dimensions: 46 x 21 x 6cm.

29136**KIT LEVEL UP**

Kit comprises of a pair of Level Ups in Grey + Level Up bag.

29115**KIT LEVEL UP JUMBO**

Kit comprises of a pair of Level Up Jumbos in Grey + Level Up bag.

29116**LEVEL BAG**

Available in 2 versions. **Level Bag** for Level Up and Level Up Jumbo and **Level Bag S** for Level Pro, Level System Magnum and Wheel Saver. It's made of Polyester and is washable. Easy to carry thanks to its comfortable shoulder belt. Colour: Black / Red

LEVEL BAG
LEVEL BAG S

29085**29084**

PLASTIC JACKS



Plastic UV-resistant jacks, in Grey. Max. load 750kg each. Half the weight of Alu Jacks. Sold in packs of 4. Adjustable in height from min 31cm to max 44cm. Each weighs only 0.8kg.

29171

ALU JACKS



Aluminium jacks, holds max, load of 1000kg each. Sold in packs of 4. Adjustable in height from min 28cm to max 43cm. Each weighs only 0.9kg.

29160

PLATES PRO



Kit of 4 anti-sinking bases supplied with 4 locks to be fastened to the vehicle's lifting jacks. Permanently secured even when travelling. Colour – Grey. Dimensions: 19x14.5cm

29203

PLATES



Kit of 4 highly reinforced anti-sinking plates. Colour – Grey. Dimensions: ø20cm.

29201

STEP MAGNUM

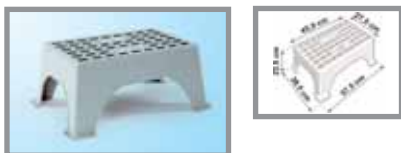

New and improved step for caravans and motorcaravans made of UV-resistant HD polyethylene for more stability and strength. Non-skid surface. Colour – Grey. Approved to hold up to 200kg. In accordance with EN1645-1646 regulations.

27710

STEP



The classic step for the motorhome and caravan, made of UV-resistant HD polyethylene for more stability and strength. Non-skid surface. Colour – Grey. Approved to hold up to 150kg.

27660

STEP-MAT



Made of soft and flexible anti-skid UV resistant rubber. Easy to position on the step thanks to the pressure joint, increasing its reliability. Available in 2 models for Step and Step Magnum. Colour – Black
 Step Mat
 Step Mat Magnum

27712

27713

COVER TOP COVER TOP



The best solution for protecting your motorhome. Sturdy and hard-wearing cover made with UV-resistant and heavy duty vinyl to protect the motorhome from dirt and sun. Easy to tighten using ropes or elastic cords (not included). Reinforced corners and tie down grommets every 40cm. One size only. Dimensions: 8.5M x 5.2M

31416

COVERGLAS XL DUCATO



Blocks out the sun and protects from UV rays, gives privacy and keeps the windscreen clean. Improved outside waterproof blind system to cover all the glasses of your vehicle cabin, extended to cover bonnet air intakes too. Made in two-layered durable material for excellent insulation from heat and cold. Suitable for Fiat Ducato after 06/2006

31410

COVERGLAS XXL DUCATO



New coverglas XXL for winter to completely cover the engine compartment. Made of insulated material, suitable for low temperatures. Composed by 2 detachable parts. The upper part covers the 3 glasses of the cabin, it is possible to uncover the windscreen without taking the Coverglas off. Excellent for winter use. Suitable for Ducato after 06/2006

31412

COVER PREMIUM



The perfect way to prevent your pride and joy from UV sun rays, leaves, dirt and dust. Made of strong and breathable fabric that prevents humidity. It maintains a cool temperature inside of the vehicle and is hand washable.

Available in 2 versions:

M for motorhomes up to 7.1M long.

Dimensions: 7.16M x 2.59M x 2.74M H

L for motorhomes up to 8M long.

Dimensions: 8.08M x 2.59M x 2.74M H

31417

31418

THERMO WALL DUCATO CABIN



Useful thermal panel to put between the cab and the camper of Fiat Ducato / Peugeot Boxer vehicles (after 2006), gives you more privacy / heat and insulation. Made of five-layered durable material.

Dimensions: 182 x 150cm H

31402

LUGGAGE BAR

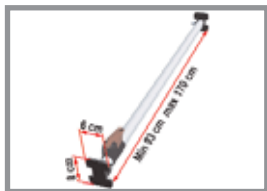

Solid telescopic bar ideal for securing objects into the garage facility whilst travelling. Rubber covered terminals to assure a steady grip without marking the walls of the vehicle. Easy to shorten to min of 93cm and max length of 170cm.

29985

CARRY DOG



New folding dog house for your pets comfort. Made from strong waterproof resin polyester. Large side windows with mosquito net, which can be rolled up for maximum ventilation. Dimensions: 75 x 49 x 55h cm (open)

14433

TABLE FITTINGS



New and improved range of modular table legs, ideal to build dismantable and revolving tables.



- Tube Pro 70cm **29971**
- Tripod Pro **30041**
- Conic Connection **30011**
- Recessed Connection **30020**
- Cap **30030**
- Adaptor for Tube Pro (for retaining table leg) **29972**

WINDOW SHADE 500



New and modern blind system for the bathroom window or caravans and motorhomes.

The blind is compact and modern looking and is made of white lacquered aluminium. Supplied with pre-mounted terminal caps. Easy to install.

Dims: Overall box length: 57cm L x 5.8cm H x 2.8cm D

30060

ALU STEP PRO



Step for caravans and motorhomes in anodised aluminium. Innovative system with folding legs for easy storage.

It carries up to 200KG. Large anti-skid surface.

It weighs only 2.95KG.

Dimensions: 47 x 34 x 4cm (when closed) – 47 x 34 x 21cm (open)

In accordance with EN1645-EN1646 regulations.

27700

CLEAN STEP



Doormat suitable for electric or manual steps fitted to your motorhome or caravan. Keeps your motorhome clean, leaving out sand and mud.

Supplied with springs. It is made from green (or black) plastic. Can be adapted to steps min size 38 x 40cm to max 45 x 40cm.

Clean Step Green

27718

Clean Step Black

27719

MUD FLAP FRONT

Pair of mudguards suitable for mounting behind the front wheels of Fiat Ducato. Made of sturdy but flexible rubber material and delivered as standard with painted steel brackets for installation to the front wheel arch of Ducato (after 2006).

Weight: 330 gr each
Dimensions: 35 x 22cm

34240**MUD FLAP REAR**

Pair of mudguards suitable for easy installation to the rear of coachbuilt motorhomes. Made of sturdy but flexible rubber material and delivered as standard with painted steel brackets for installation on the rear of most motorhomes. You can use more Mud Flap Rear at the same time so to create a continuous wall at the end of the motorhome. Weight: 560gr each.

Dimensions: 30 x 35cm

34241**PACK WASTE**

New Fiamma folding dustbin that can be placed wherever is convenient. Pack Waste is delivered with hooks and retainer brackets. When closed Pack Waste takes up minimal room, when opened Pack Waste is very roomy. It takes 40L plastic bags.

13980**MOSKITO NET**

Mosquito screen for motorhome door consisting of 2 overlapping panels. Each panel is 230cm high and 35cm wide. The bottom of each panel is reinforced and stays taut. Easily installed by sliding into wall track provided. Adjustable in height.

28560**OMNI STOP**

An innovative yet simple accessory, ideal to keep your plates and items in place whilst you travel. Easy to block and unblock.

Securing bar made from anodised aluminium.

25cm high. 20cm long. Support handle in sturdy plastic.

30044**DRIP STOP**

Drip stop mini-gutter eliminates black streaks from your RV. The gutter is made in wide base flexible polyvinyl. Adhesive acrylic foam of superior quality and adherence is reinforced with aluminium strips that guarantee long life and hold over the years. Easy to install, UV-ray proof.

Colour – White. Available in 2 lengths

DRIP STOP 75CM

28180

DRIP STOP 300CM

28190

DRIP STOP 1000CM

28192**GARAGE CARRY RAIL**

The clothes rack ideal for the storage compartment of motor-homes. Consists of sturdy, lightweight anodised aluminium pole supported by 2 ceiling fixings. Dims: 1M (easy to shorten).

13947

FIAMMA POPULAR SPARE PARTS



Leg Top 07 on
2.5M – 3.5M
71524



Leg Top 07
4.0M – 5.5M
71526



Leg Top
Caravanstore
71540



Leg Top F45TiL
08 on
Sold as pairs
71527



Installation kit
awning box –
Privacy Room
71509



Installation kit
awning box 08
71500



Gear Box for
smaller case (F45)
awnings
77003



Gear Box for larger
case (F45)
awnings from 08
78040



Installation kit
Awning Bar –
Privacy Room
71508



Leg bracket kit
71550



Leg knuckle LH
2.5M – 3.5M
70894



Leg knuckle RH
2.5M – 3.5M
70896



LH Swivel holder
F45TiL
70902



LH Swivel F45TiL
70903



Caravanstore
Bullets (pr)
71538

Leg knuckle LH
4.0M – 5.5M
70898

Leg knuckle RH
4.0M – 5.5M
70900

RH Swivel holder
F45TiL
70904

RH Swivel
F45TiL
70905



Installation kit F65
Privacy Room – (pr)
78230



LH clip system fit kit
box
76993



LH clip system fit kit
(lead bar)
76995



Winding eye F45i /
F45Ti
77008



Leg pins
71498

RH clip system fit
kit box
76994

RH clip system
fit kit (lead bar)
76996